



Part of the  
Bathroom Brands Group  
+44 (0)1322 473 222  
info@bathroombrands.com  
burlingtonbathrooms.com

Lake View House  
Rennie Drive,  
Dartford  
Kent, DA1 5FU



*Burlington*

burlingtonbathrooms.com

April 2019



*Burlington*<sup>®</sup>



*Burlington*<sup>®</sup>

*INSPIRATION*    *pages 02-47*

*BATHS*    *pages 122-141*

*BASINS*    *pages 50-77*

*BRASSWARE*    *pages 142-157*

*WC'S*    *pages 78-95*

*SHOWERING*    *pages 158-187*

*FURNITURE*    *pages 96-121*

*ACCESSORIES*    *pages 186-200*

From the late 1800's into the 1900's, Britain led the way in bathroom design and performance. Our time honoured Burlington and Arcade bathrooms bring a complete collection of traditional products all with modern functionality. These ranges allow you to create a traditional bathroom that can reflect the historical eras of great design across Edwardian, Victorian, Classic, Contemporary or Arcade's unique Belle Époque style.

The latest technology is utilised throughout the Burlington and Arcade product ranges to bring important benefits such as stay-clean Nano glaze coating on all WC bowls, ceramic disc options on all brassware and all showers with safe thermostatic operation including digital control.

Our extensive portfolio is designed to solve all your design challenges with a vast range of models that will suit every plumbing installation. Bathroom furniture, that provides many storage solutions, can complete the look you want and is available in four finishes. See the Technical Directory which starts on page 50 for the complete choice. Whatever you choose you can be sure Burlington and Arcade products will work perfectly together.





Your bathroom space should be one in which you feel completely at home, a space that reflects your unique personality and individual tastes. It's a space for rejuvenation, pampering, relaxation as well as an environment for the necessities of a daily routine.

You may already have an idea of the style of bathroom you're looking to create or you may need further guidance to help you configure your ideal traditional bathroom. The following pages in this brochure have been designed to help inspire with some of our suggested product pairings. Or you may spot something you can mix and match with product on subsequent pages. However you configure your beautifully traditional bathroom, we're sure you'll find just what you're looking for from Burlington and Arcade bathrooms.

Edwardian 1200mm basin with washstand and Claremont three tap hole basin mixer with pop-up waste.





*CLASSIC INVISIBLE OVERFLOW BASIN*

Our products are faithful reproductions of historical designs. This Classic basin is based on a model called Cliffe Vale produced in 1896 and described at the time as “a basin with improved waste and overflow”. It’s unique waste means there is no requirement for a plug or external waste. Simply pull the lever up to drain water.



Classic basin with invisible overflow, classic pedestal and Claremont two tap hole 5" basin taps. Tumbler holder and towel ring.





Our furniture is a beautiful representation of traditional design available in 4 classic yet contemporary colours perfect for the modern day bathroom; Matt White, Sand, Dark Olive or the NEW Classic Grey. Seamlessly carry through your colour selection to bath surrounds and WC seats for a consistent look.

AVAILABLE FURNITURE COLOURS



Above: Classic 510mm basin, Free-standing Matt White cloakroom vanity unit with single door and Chelsea straight basin mixer with pop-up waste.



Classic Grey 1340mm Curved free-standing vanity unit, Carrara White worktop and Kensington regent three tap hole basin mixer with pop up waste. Arched mirror and ornate lights with vase shades.



*CREATE A STUNNING STATEMENT IN BLACK*

For added flair, select the brassware with Black ceramic levers and indices. There are coordinating Black products available across toilet seats, aluminium washstands, high level cisterns, radiators, mirrors and bath feet to create a dramatic bathroom statement.



Carrara marble basin, Black aluminium washstand with shelf, Kensington Black three tap hole basin mixer, Black aluminium mirror, towel ring and round lights with chiffon shades. Standard high level WC with soft-close Matt Black seat, dual flush Black aluminium cistern and spire toilet roll holder. Bateau bath with claw Black feet.





Bateau bath with claw Black feet and Kensington Black bath shower mixer on stand pipes.



High level Black aluminium cistern.



*THE WALNUT COLLECTION*

For a premium option, select the Walnut trim for your Kensington taps, cistern lever or bath shower mixer. There are coordinating solid Walnut products available across toilet seats, brassware and accessories, to add the finishing touches to your traditional bathroom.

**Left:** Classic 650 rectangular basin with Kensington Walnut three tap hole basin mixer. **Top Right:** Tumbler holder with Walnut back plate. **Lower Right:** Edwardian 515 rectangular cloakroom basin with Kensington Walnut 3" taps





*THE EDWARDIAN COLLECTION*

The Edwardian basin design has a refined structure with strong lines and an impressive stance. Available in a range of sizes; 560mm in either a rectangular or a round design, or 610mm, 800mm and 1200mm rectangular basins each available with corresponding pedestals and washstands.



**Left:** Edwardian 560mm basin, standard pedestal and Birkenhead two tap hole 5" pillar taps and plug and chain basin waste. Standard close-coupled WC with 520mm lever cistern and White soft-close seat.



*THE STUNNING LONDON BATH*

The double-ended London Round has a simple purity of form that will enhance any style of décor in your home.

London Round soaking tub and Black Kensington bath shower mixer on stand pipes.







Edwardian 800mm basin, traditional bottle trap, chrome washstand and Birkenhead three tap hole basin mixer.



Standard low level WC with 520mm lever cistern, White soft-close seat and WC toilet roll holder.



*THE ARCADE COLLECTION*

Arcade is a timeless collection and provides the ultimate in luxurious bathroom styling. Arcade's ranges of exquisitely crafted pieces are lovingly hand finished to achieve an iconic Belle Époque appearance. Choose from fixtures and fittings in either chrome or nickel for a truly individual look.



**Above:** 500mm Cloakroom basin, bottle trap and Mini crosshead basin mixer.

**Right:** Chrome wall-mounted WC roll holder with brass bar. Open back close-coupled WC, dual flush cistern and Gloss Black soft-close seat. 900mm basin with overflow, chrome bottle trap, chrome stand, three tap hole deck-mounted basin mixer with chrome levers and square swivel mirror.







*THE BALTHAZAR BATH*

The NEW Balthazar, crafted from ClearStone is a double-ended bath providing an eye-catching centrepiece to your bathroom with its lustrous, glossy interior and stainless steel outer. Also available with pure White outer or intense Black outer. See page 124 for all finishes.



Balthazar bath in ClearStone with stainless steel outer and Kensington bath shower mixer on stand pipes.



*FREE-STANDING OR FITTED FURNITURE*

Our traditional storage solutions add a sophisticated elegance to your bathroom. Whether you prefer a square or curved design, free-standing or wall-hung options or a fitted furniture solution combining base units such as basin and WC units, full height storage and wall units to fit your designated space.

*AVAILABLE FURNITURE COLOURS*



1300mm free-standing vanity unit with doors, Minerva copper fleck double vanity bowl with two Chelsea basin mixers and two arched mirrors.

600mm mirrored double door wall unit, 600mm double door wall unit, 300mm single door wall unit, 600mm base unit for semi-recessed basin, semi-recessed 580mm basin, Chelsea basin mixer, 600mm WC unit, wall-hung WC and Matt White soft-close seat. Two Minerva Carrara White 1200mm worktops and joining kit. Towel ring and Trafalgar radiator.







*THE VICTORIAN COLLECTION*

This versatile basin features a delicate and refined edge with a simplicity that blends beautifully with its surroundings. Available in both 560mm and 610mm sizes with a range of pedestal and washstand options.



**Left:** 610mm Victorian basin, standard pedestal and Claremont 5" basin taps. Rectangular mirror and Bloomsbury radiator.

**Above left:** 650mm Natural stone basin, stainless steel basin stand, traditional bottle trap, Claremont basin mixer with pop-up waste and rectangular mirror.

**Above right:** 610mm Victorian basin, chrome washstand, traditional bottle trap, Claremont basin mixer with pop-up waste and tumbler holder.





Buckingham bath, luxury White arc feet and Claremont deck-mounted bath shower mixer with decorative shrouds. High level WC, White ceramic cistern with oak throne seat. 610mm Victorian basin, standard pedestal, Claremont 5" basin taps, rectangular mirror, Cleaver towel warmer, soap dish and round lights with chrome base and chiffon Silver shades.

560mm Victorian basin, semi-pedestal with towel rail and Claremont 5" basin taps.







580mm Contemporary basin, semi-pedestal and Claremont basin mixer. Triple robe hook, single soap dispenser, ornate lights with chrome bases and tube frosted glass shades and WC roll holder. Wall-hung WC, Sand soft-close seat with concealed cistern and WC brush holder. Arundel bath, plug and chain bath waste with Sand front and end panels and Claremont deck-mounted bath filler.



*EDWARDIAN ROUND*

The Edwardian round basin combines strength of character with a soft, balanced nature. Available as a 560mm size with either one or two tap holes, it can be paired with pedestals or chrome washstands in standard and regal heights.



560mm Edwardian round basin, chrome washstand and Kensington 5" taps with plug and chain waste. Tumbler holder.





**Left:** 560mm Edwardian round basin and chrome washstand with Kensington 5" taps, plug and chain waste and tumbler holder. Back-to-wall WC, White soft-close seat, concealed cistern with lever and spare WC roll holder.

**Above:** Blenheim bath, White arc feet and deck-mounted Kensington bath shower mixer with 'S' adjuster and plug and chain waste.



510mm Classic square basin, chrome washstand and Claremont 3" pillar taps with plug and chain waste and soap dish.



*THE CLASSIC COLLECTION*

The Classic basin collection features a 510mm square design, which is available with a corresponding cloakroom furniture unit or standard chrome washstand. Our 650mm rectangular basins are available as one, two, or three tap hole options. Pair with pedestals, furniture or on chrome or aluminium washstands. A 650mm round design is also available with one, two or three tap holes and can be paired with a simple, ceramic pedestal.





1340mm White curved free-standing vanity unit, Minerva Carrara marble worktop and Kensington three tap hole basin mixer with pop-up waste. Arched mirror and Burlington round lights with chrome bases and vase clear glass shades. Standard medium level WC, 520mm lever cistern, White soft-close seat and WC roll holder.





**Left:** 650mm Classic rectangular basin, traditional bottle trap, distressed aluminium washstand and Claremont 5" taps. Distressed aluminium frame mirror.

**Above:** 1650mm Admiral double-ended bath and Kensington floor-standing bath shower mixer with exposed chrome waste and overflow.



*FINISHING TOUCHES*

Our range of accessories will provide the finishing touches to ensure your bathroom looks and functions perfectly. From classically styled chrome soap dishes, to ceramic toothbrush holders, every item is traditionally crafted in chrome plated solid brass, to guarantee the balance of functionality and style.

*FOR OUR FULL RANGE OF ACCESSORIES SEE PAGE 188*

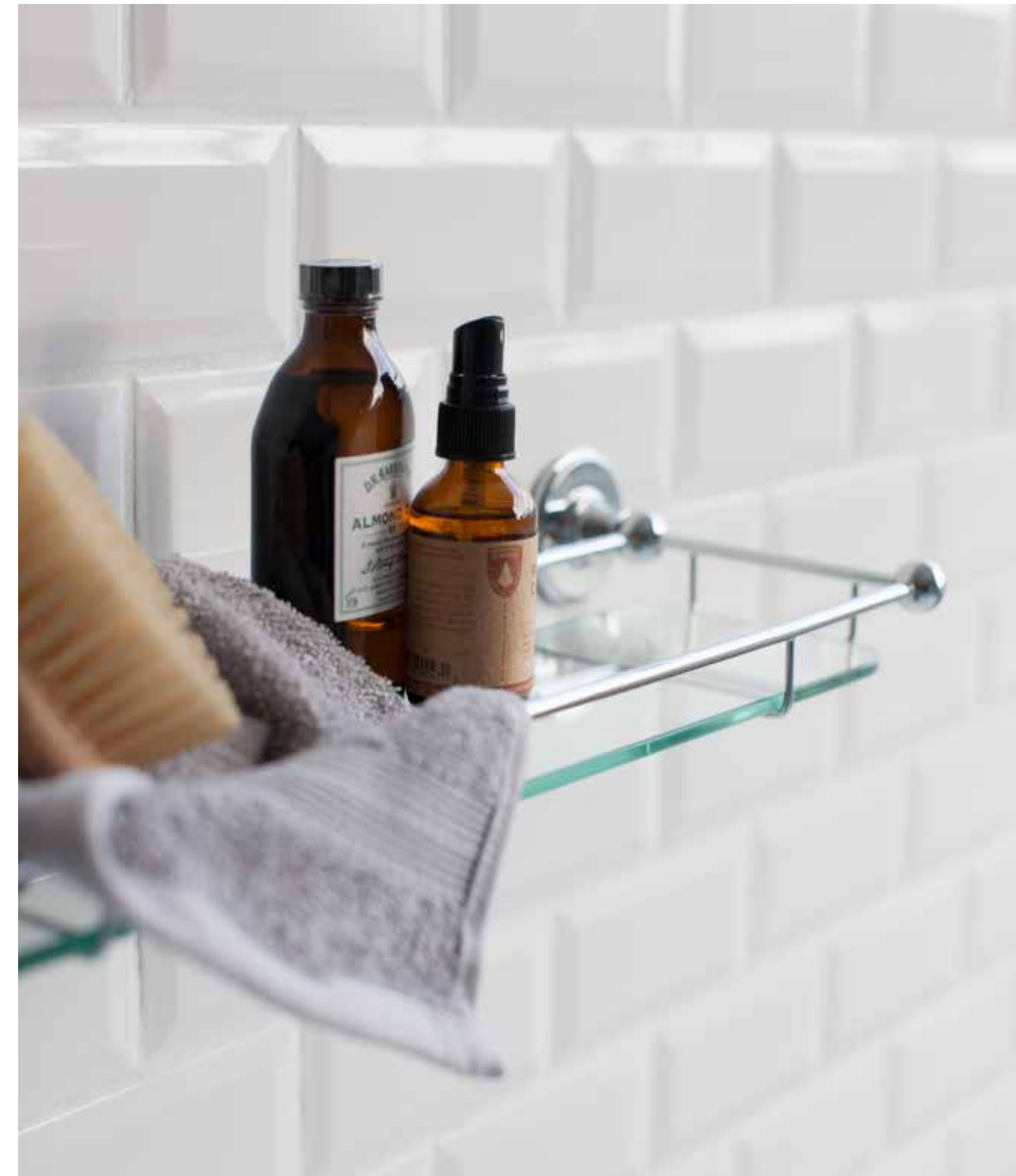

Left: Tumbler holder  
Above: Glass shelf with railing





Standard high level WC, dual flush White aluminium cistern and White soft-close seat. 560mm Edwardian round basin, traditional bottle trap, chrome washstand and Claremont 5" taps with plug and chain waste. Hampton 1500mm left-handed bath,

chrome arc feet, bath screen with access panel and Claremont deck-mounted bath filler with plug and chain waste. 1910 Digital shower, 9" airburst shower head and wall arm. Corner basket.



*BURLINGTON SHOWERING*

Our extensive range of showering options ensures the perfect solution for your bathroom. Whether you are showering over a bath, or in a separate shower, our thermostatic valves have the latest in safe operation. We use the latest and best technology in all our shower mixers for the fastest and safest response. The 1910 digital models are TMV2 approved. For the ultimate in operation, our 1910 digital shower has visual coloured temperature indication and the option of remote control.



**Above:** Classic 1910 Digital dual outlet shower sets shown with temperature changes.

**Right:** Black Trent thermostatic dual function brass valve with independent flow diverter and temperature control. Traditional brass faceplate and Claremont handle. Wall outlet and 1500mm shower hose. Adjustable wall bracket and handset with ceramic handle. 390mm adjustable shower arm.





# *TECHNICAL DIRECTORY*

You have now been introduced to the wide scope of the Burlington and Arcade ranges, all designed and engineered to provide solutions for your bathroom. The following Technical Directory provides a full listing of the Burlington and Arcade products including product codes and dimensions. Visit our website [burlingtonbathrooms.com](http://burlingtonbathrooms.com) or for our full database [bbwhitebook.com](http://bbwhitebook.com) if you need further details. Whatever you choose, we are sure you will be delighted with your traditional bathroom by Burlington.

## *BASINS*

- 50 Burlington
- 72 Arcade

## *WCS*

- 78 Burlington
- 94 Arcade

## *FURNITURE*

- 98 Burlington

## *BATHS*

- 122 Burlington
- 140 Arcade

## *BRASSWARE*

- 142 Burlington
- 152 Arcade

## *SHOWERING*

- 158 Burlington
- 174 Arcade

## *ACCESSORIES*

- 186 Burlington
- 196 Arcade



# BASINS



**Classic**



The Classic collection from Burlington is beautifully formed, available in round or square designs, complete with an invisible waste option.

**Edwardian**



The Edwardian collection is the ultimate in traditional bathrooms with structured corners and angular designs, the feel is unapologetic and proud.

**Victorian**



Delicate and refined, the simplicity of this basin is stunning whilst its versatility allows you to continue the style through your home and brings an air of luxury.

**Contemporary**



As the name suggests, the Contemporary collection is styled on the elegance of past times but with a modern day twist. Simplistic, structured lines form the basis for this striking ceramic collection.

**Cloakroom**



A choice of traditionally designed cloakroom basins to achieve a consistent look throughout the home.



*BASIN OPTIONS*

Burlington Regal pedestals are higher than standard pedestals, making them more comfortable for taller people, the elderly or those prone to back pain.



	Standard	Regal
Classic	860mm	920mm
Victorian	840mm	900mm
Edwardian	840mm	900mm
Contemporary	840mm	900mm

*WASHSTAND OPTIONS*

Our chrome washstands are also available in a Regal height and are compatible with Classic, Edwardian, Victorian, Contemporary, Cloakroom and Georgian basins. With an increased height of 60mm, they provide an ergonomic use for taller people and those who need it.

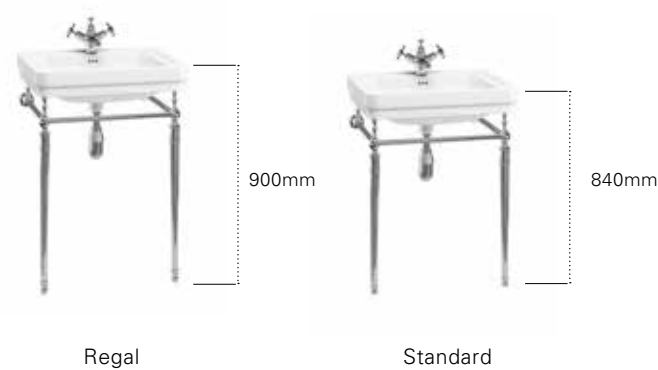

*CLASSIC ROUND & SQUARE BASINS*

Select your basin shape



Classic 650mm round basin shown with standard pedestal  
 W: 650 D: 580 H: 860  
 Basin: B17\*  
 Pedestal: P6

Classic 510mm square basin shown with standard chrome washstand  
 W: 510 D: 450 H: 890  
 Basin: B20\*\*  
 Washstand: T52 CHR

*ONE, TWO, OR THREE TAP HOLE*

Select the brassware look you prefer with a choice of 1, 2 or 3 tap hole basins. Simply add 1TH, 2TH or 3TH to the end of your desired basin code. See page 142 to choose your corresponding brassware.

\* The Classic 650mm round basin is available with one, two or three tap holes. To order the correct basin configuration simply replace '\*\*' with 1TH, 2TH or 3TH.  
 \*\* Classic 510mm basin only available in 1TH or 2TH configuration



## CLASSIC RECTANGULAR BASINS

Select your basin shape



Classic 650mm rectangular basin



Classic 650mm rectangular basin shown with distressed aluminium washstand  
W: 650 D: 575 H: 860  
Basin: B15\*  
Washstand: T38 ALU



Classic 650mm rectangular basin shown with Black aluminium washstand  
W: 650 D: 575 H: 860  
Basin: B15\*  
Washstand: T48 BLA



Classic 650mm rectangular basin shown with White aluminium washstand  
W: 650 D: 575 H: 860  
Basin: B15\*  
Washstand: T43 WHI



Classic 650mm rectangular basin shown with chrome washstand  
W: 650 D: 575 H: 860  
Basin: B15\*  
Washstand: T49A CHR



Classic 650mm rectangular basin shown with standard pedestal  
W: 650 D: 575 H: 860  
Basin: B15\*  
Pedestal: P6

### OPT FOR A TALLER BASIN INSTALLATION

Basin shapes	Size	Regal round pedestal	Regal chrome washstand
Rectangular	650 x 575	P9R	T49A CHR+T62
Round	650 x 575	P9R	
Square	510 x 450		T52 CHR+T62



Regal round pedestal



Regal chrome washstand

920mm

920mm

**nanogLAZE**  
ceramic that stays cleaner

Classic basins feature a unique stay-clean NANO Glaze coating, creating an ultra-smooth surface, six times smoother than standard ceramic.

\* Classic basins are available with one, two or three tap holes. To order the correct basin configuration simply replace '\*\*' with 1TH, 2TH or 3TH.

\* The Classic 650mm rectangular basin is available with one, two or three tap holes. To order the correct basin configuration simply replace '\*\*' with 1TH, 2TH or 3TH.





**CLASSIC INVISIBLE OVERFLOW BASINS**



Classic 650mm rectangular invisible overflow basin shown with standard pedestal  
W: 650 D: 575 H: 860  
Basin: B14\*  
Pedestal: P6



Classic 650mm rectangular invisible overflow basin shown with distressed aluminium washstand  
W: 650 D: 575 H: 860  
Basin: B14\*  
Washstand: T38 ALU



Classic 650mm rectangular invisible overflow basin shown with Black aluminium washstand  
W: 650 D: 575 H: 860  
Basin: B14\*  
Washstand: T38 BLA



Classic 650mm rectangular invisible overflow basin shown with White aluminium washstand  
W: 650 D: 575 H: 860  
Basin: B14\*  
Washstand: T38 WHI



Classic 650mm rectangular invisible overflow basin shown with chrome washstand  
W: 650 D: 575 H: 860  
Basin: B14\*  
Washstand: T49A CHR



Classic basin invisible overflow and waste  
W: 300 D: 74 H: 74  
Code: W9

**OPT FOR A TALLER BASIN INSTALLATION**

Basin shapes	Size	Regal round pedestal	Regal chrome washstand
Rectangular	650 x 575	P9R	T49A CHR+T62



Regal round pedestal



Regal chrome washstand

**INVISIBLE OVERFLOW WASTE**

Available with the Classic collection as a two tap hole configuration

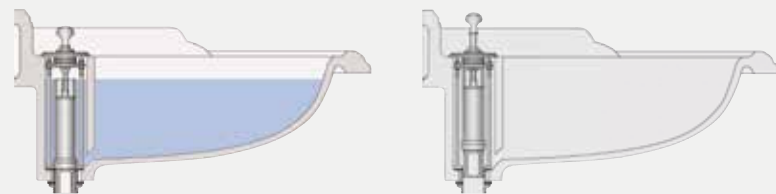

The benefit of invisible overflow is that the ceramic of the beautiful basins is un-interrupted with no requirement for a plug or external waste. Simply pull the lever to drain water. Pair with the elegant and beautiful Arch basin mixer allowing you to mix hot and cold water.

**TWO TAP HOLE OPTION**



Turn to page 144 to see the two tap hole options that can be paired with your Classic invisible overflow basin.

\* This Classic basin choice is only compatible with 2TH. To order the correct basin configuration simply replace "\*" with 2TH.



# EDWARDIAN BASINS

Select your basin shape



Edwardian 560/610/800/1200mm rectangular basin



Edwardian 560mm rectangular basin shown with standard pedestal  
W: 560 D: 470 H: 840  
Basin: B4\*  
Pedestal: P1

Edwardian 610mm rectangular basin shown with standard pedestal  
W: 610 D: 510 H: 840  
Basin: B5\*  
Pedestal: P1

Edwardian 800mm rectangular basin shown with standard pedestal  
W: 800 D: 510 H: 840  
Basin: B18\*  
Pedestal: P6

Edwardian 1200mm rectangular basin shown with standard pedestal  
W: 1200 D: 510 H: 840  
Basin: B19\*  
Pedestal: P6



Edwardian 560mm rectangular basin shown with chrome washstand  
W: 560 D: 470 H: 840  
Basin: B4\*  
Washstand: T22A CHR

Edwardian 610mm rectangular basin shown with chrome washstand  
W: 610 D: 510 H: 840  
Basin: B5\*  
Washstand: T23A CHR

Edwardian 800mm rectangular basin shown with chrome washstand  
W: 800 D: 510 H: 840  
Basin: B18\*  
Washstand: T50 CHR

Edwardian 1200mm rectangular basin shown with chrome washstand  
W: 1200 D: 510 H: 840  
Basin: B19\*  
Washstand: T51 CHR

## OPT FOR A TALLER BASIN INSTALLATION

Basin shapes	Size	Regal pedestal	Regal chrome washstand
Rectangular	560 x 470	P9	T22A CHR+T62
Rectangular	610 x 510	P9	T23A CHR+T62
Rectangular	800 x 510	P9R	T50 CHR+T62
Rectangular	1200 x 510	P9R	T51 CHR+T62
Round	560 x 470	P9	T24A CHR+T62



Regal pedestal (P9)

Regal round pedestal (P9R)



Regal chrome washstand

\*Edwardian 560mm and 610mm Rectangular basins are available with regal pedestal P9. Edwardian 800mm and 1200mm basins are available with regal round pedestal P9R as displayed opposite.

\*Edwardian Rectangular basins are available with one, two or three tap holes. To order the correct basin configuration simply replace '\*\*' with 1TH, 2TH or 3TH. 3 tap hole basins and the 800mm and 1200mm basin cannot be used with the semi-pedestal.

\*Edwardian Rectangular basins are available with one, two or three tap holes. To order the correct basin configuration simply replace '\*\*' with 1TH, 2TH or 3TH. 3 tap hole basins and the 800mm and 1200mm basins cannot be used with the semi-pedestal.





## EDWARDIAN BASINS

Select your basin shape

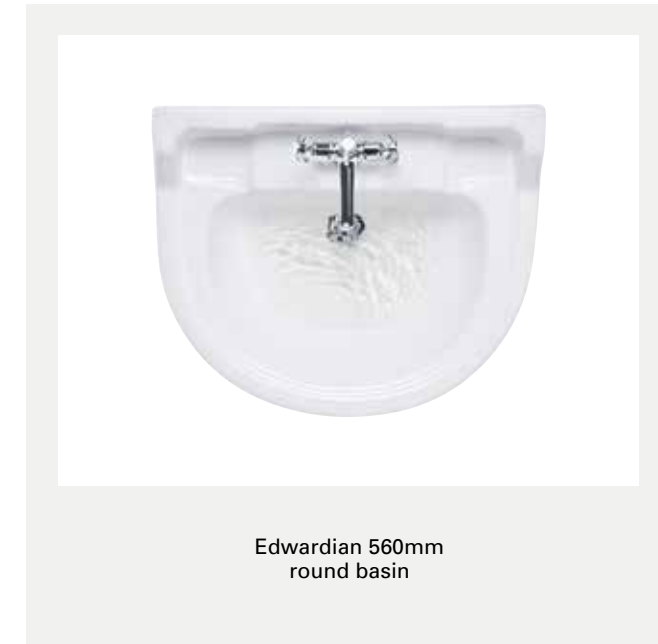

Edwardian 560mm rectangular basin shown with semi-pedestal  
W: 560 D: 470  
Basin: B4\*  
Pedestal: P8



Edwardian 610mm rectangular basin shown with semi-pedestal  
W: 610 D: 510  
Basin: B5\*  
Pedestal: P8

### TOWEL RAILS



Add a towel rail to your basin.

**Rectangular**  
560mm basin  
T1 CHR  
610mm basin  
T3 CHR

**Round**  
560mm basin  
T4 CHR



Edwardian 560mm round basin shown with standard pedestal  
W: 560 D: 470 H: 840  
Basin: B6\*  
Pedestal: P1



Edwardian 560mm round basin shown with chrome washstand  
W: 560 D: 470 H: 840  
Basin: B6\*  
Washstand: T24A CHR

### ONE OR TWO TAP HOLE



Select the brassware look you prefer with a choice of 1 or 2 tap hole basins. Simply add 1TH or 2TH to the end of your desired basin code. See page 144 to choose your corresponding brassware.

\*Edwardian round basins are available with one or two tap holes. To order the correct basin configuration simply replace "\*" with 1TH or 2TH.



# VICTORIAN BASINS

Select your basin shape

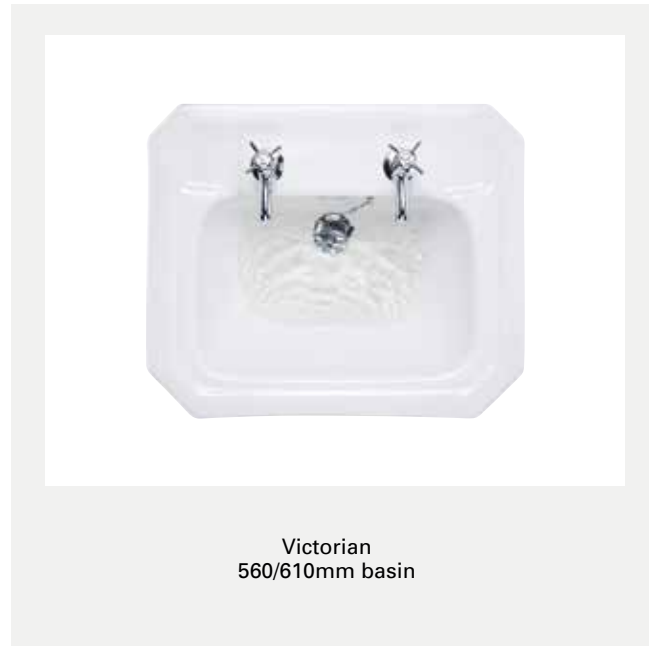

Victorian  
560/610mm basin



Victorian 560mm  
basin shown with  
chrome washstand  
W: 560 D: 470 H: 840  
Basin: B2\*  
Washstand: T22A CHR

Victorian 610mm  
basin shown with  
chrome washstand  
W: 610 D: 510 H: 840  
Basin: B3\*  
Washstand: T23A CHR

### OPT FOR A TALLER BASIN INSTALLATION

Basin shapes	Size	Regal pedestal	Regal chrome washstand
Rectangular	560 x 470	P9	T22A CHR+T62
Rectangular	610 x 510	P9	T23A CHR+T62



Victorian 560mm  
basin shown with  
standard pedestal  
W: 560 D: 470 H: 840  
Basin: B2\*  
Pedestal: P1



Victorian 610mm  
basin shown with  
standard pedestal  
W: 610 D: 510 H: 840  
Basin: B3\*  
Pedestal: P1



Victorian 560mm  
basin shown with  
semi-pedestal  
W: 560 D: 470  
Basin: B2\*\*  
Pedestal: P8



Victorian 610mm  
basin shown with  
semi-pedestal  
W: 610 D: 510  
Basin: B3\*\*  
Pedestal: P8

### ONE, TWO, OR THREE TAP HOLE



Select the brassware look you prefer with a choice of 1, 2 or 3 tap hole basins. Simply add 1TH, 2TH or 3TH to the end of your desired basin code. See page 144 to choose your corresponding brassware.

### TOWEL RAILS



Add a towel rail to your basin.

560mm basin  
T1 CHR  
610mm basin  
T3 CHR

\* Victorian basins are available with one, two or three tap holes. To order the correct basin configuration simply replace '\*\*' with 1TH, 2TH or 3TH.  
\*\* 3TH basins cannot be used with semi-pedestals

\* Victorian basins are available with one, two or three tap holes. To order the correct basin configuration simply replace '\*\*' with 1TH, 2TH or 3TH.  
\*\* 3TH basins cannot be used with semi-pedestals



## CONTEMPORARY BASINS

Select your basin shape

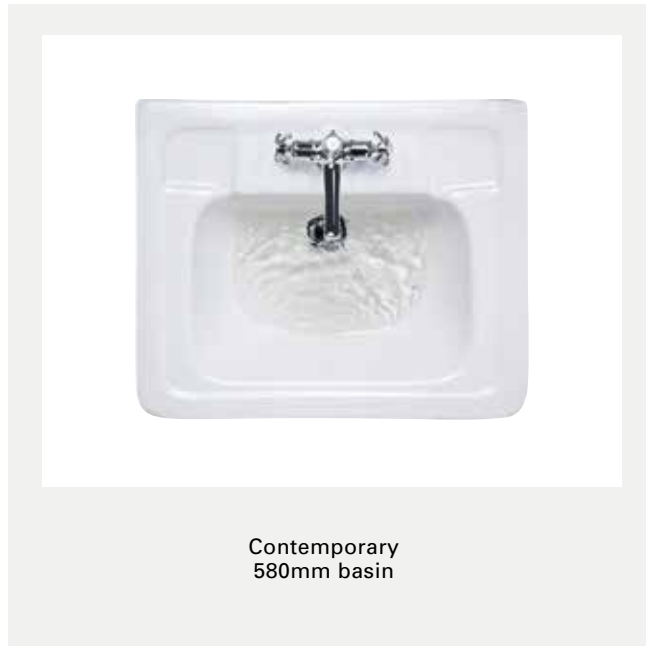

### ONE, TWO, OR THREE TAP HOLE



Select the brassware look you prefer with a choice of 1, 2 or 3 tap hole basins. Simply add 1TH, 2TH or 3TH to the end of your desired basin code. See page 144 to choose your corresponding brassware.

### OPT FOR A TALLER BASIN INSTALLATION

Basin shapes	Size	Regal pedestal	Regal chrome washstand
Rectangular	580 x 470	P9	T22A CHR+T62



Contemporary 580mm basin shown with standard pedestal  
W: 580 D: 470 H: 840  
Basin: B1\*  
Pedestal: P1



Contemporary 580mm basin shown with semi-pedestal  
W: 580 D: 470  
Basin: B1\*  
Pedestal: P8



Contemporary 580mm basin shown with chrome washstand pedestal  
W: 580 D: 470 H: 840  
Basin: B1\*  
Washstand: T22A CHR



### TOWEL RAILS

Add a towel rail to your basin.

580mm basin  
T2 CHR

### SEMI-RECESSED & COUNTERTOP BASINS



580mm semi-recessed basin  
W: 575 D: 470  
Basin: B12\*\*



540mm countertop basin  
W: 575 D: 470  
Basin: B13\*\*

\* Contemporary basins are available with one, two or three tap holes. To order the correct basin configuration simply replace \*\* with 1TH, 2TH or 3TH.  
\*\* Semi-recessed and countertop basins available as one or two tap holes

## NATURAL STONE BASINS

Select your basin shape

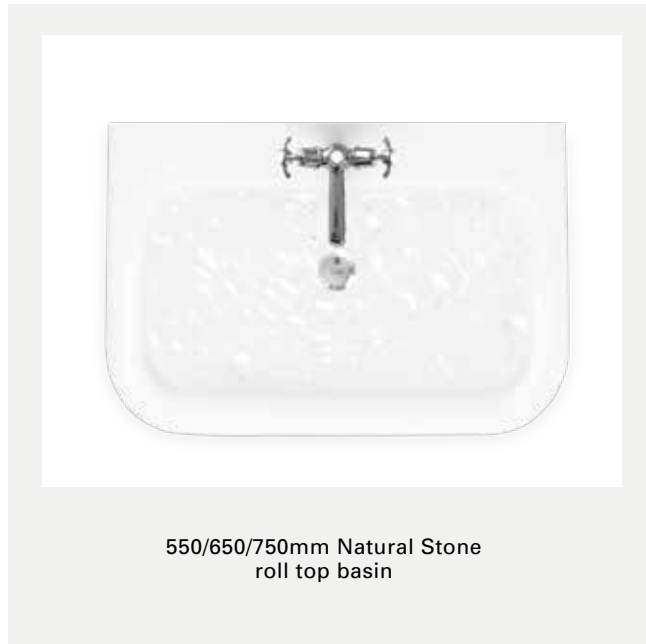

Small roll top basin with stainless steel stand

W: 550 D: 470 H: 880

Basin: B7E\*  
Washstand: B7ES



Medium roll top basin with stainless steel stand

W: 650 D: 470 H: 880

Basin: B8E\*  
Washstand: B8ES



Large roll top basin with stainless steel stand

W: 750 D: 470 H: 880

Basin: B9E\*  
Washstand: B9ES

\* Natural Stone basins are supplied undrilled for your preferred choice of 1, 2 or 3 taphole. Tap holes are drilled by the installer in the required position and configuration









# GEORGIAN MARBLE BASINS

Select your basin shape



Georgian Marble  
650mm basin

			
<p>650mm Georgian Marble basin shown with distressed aluminium washstand with shelf</p> <p>W: 650 D: 575 H: 805</p> <p>Basin: G1* Washstand: T38 ALU + G11</p>	<p>650mm Georgian Marble basin shown with Black aluminium washstand with shelf</p> <p>W: 650 D: 575 H: 805</p> <p>Basin: G1* Washstand: T38 BLA + G11</p>	<p>650mm Georgian Marble basin shown with White aluminium washstand with shelf</p> <p>W: 650 D: 575 H: 805</p> <p>Basin: G1* Washstand: T38 WHI + G11</p>	<p>650mm Georgian Marble basin shown with standard chrome washstand</p> <p>W: 650 D: 575 H: 805</p> <p>Basin: G1* Washstand: T49A CHR</p>

		
<p>650mm Georgian Marble basin shown with distressed aluminium washstand</p> <p>W: 650 D: 575 H: 805</p> <p>Basin: G1* Washstand: T38 ALU</p>	<p>650mm Georgian Marble basin shown with Black aluminium washstand</p> <p>W: 650 D: 575 H: 805</p> <p>Basin: G1* Washstand: T48 BLA</p>	<p>650mm Georgian Marble basin shown with White aluminium washstand</p> <p>W: 650 D: 575 H: 805</p> <p>Basin: G1* Washstand: T43 WHI</p>



**OPT FOR A TALLER BASIN INSTALLATION**

Size	Regal chrome washstand
650 x 575	T49A CHR+T62



Regal chrome washstand

**ONE, TWO, OR THREE TAP HOLE UPSTANDS**

Select the brassware look you prefer with a choice of 1, 2 or 3 tap hole basins. Simply add 1TH, 2TH or 3TH to the end of your desired basin code. See page 144 to choose your corresponding brassware.

Your Georgian marble basin comes with rear and side upstands so you can tailor to your preferred look.

\*Marble basins are available with no tap hole, 1 tap hole, 2 tap hole or 3 tap hole. To order the correct basin configuration simply replace '\*' with 0TH, 1TH, 2TH or 3TH. Marble upstands can be installed with rear and side upstands, rear upstand only or no upstand.

## CLOAKROOM BASINS

Select your basin shape

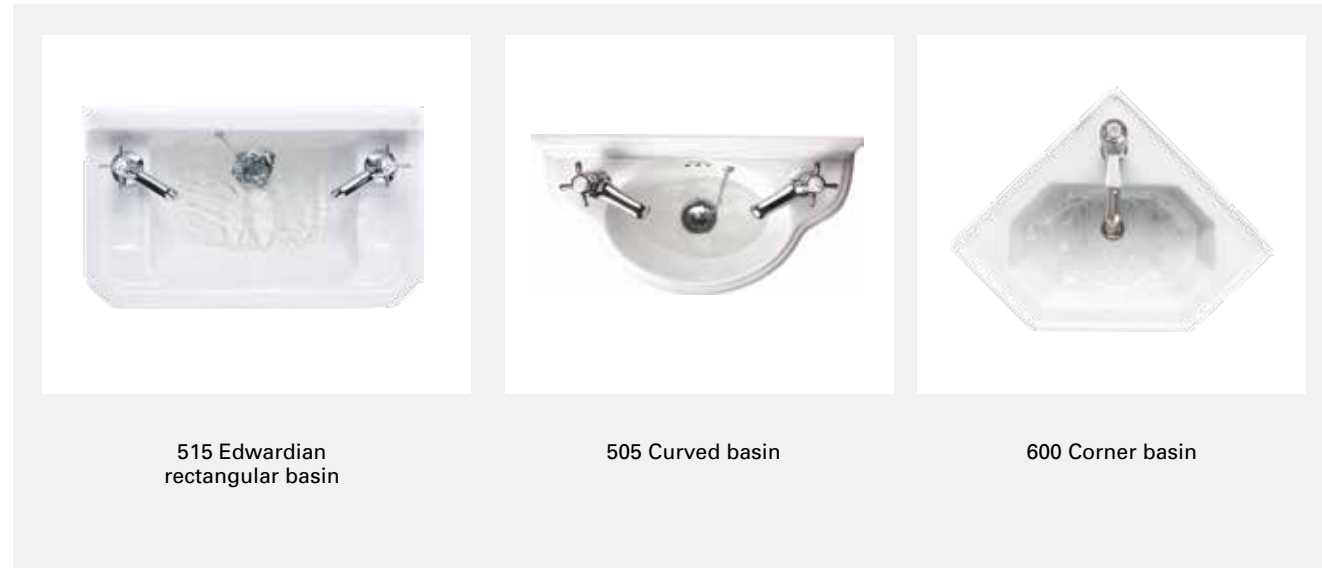

515 Edwardian rectangular basin

505 Curved basin

600 Corner basin



515 Edwardian rectangular basin with chrome washstand  
W: 515 D: 308 H: 825  
Basin: B8\*  
Washstand: T21A CHR

515 Edwardian rectangular basin  
W: 515 D: 308  
Basin: B8\*  
\*Edwardian & Curved Cloakroom basins are available with one tap hole on the right. To order this simply add 'R' to the product code.

505 Curved basin  
W: 505 D: 255  
Basin: P13\*  
\*Edwardian & Curved Cloakroom basins are available with one tap hole on the right. To order this simply add 'R' to the product code.

600 Corner basin  
W: 600 D: 450  
Basin: B10

### OPT FOR A TALLER BASIN INSTALLATION

Basin shapes	Size	Regal chrome washstand
Edwardian Rectangular	515 x 308	T21A CHR+T62



Regal chrome washstand

### TOWEL RAILS



Add a towel rail to your Edwardian basin.  
T6 CHR



# ARCADE BASINS



Arcade

Basins



**500mm cloakroom basin with overflow**  
W: 500 D: 400  
Basin: ARC500\*



**600mm basin with overflow & pedestal**  
W: 605 D: 525 H: 840  
Basin: ARC600\*  
Pedestal: ARC1



**900mm basin with overflow & pedestal**  
W: 905 D: 550 H: 840  
Basin: ARC900\*  
Pedestal: ARC1

Compatible wastes: ARCW19, ARCW14 (Add NKL for Nickel, CHR for Chrome). If a chrome overflow ring is required, A68 CHR can be ordered free of charge from your dealer. ARC500 basin is available with one or two tap holes. ARC600 and ARC900 basins are available with no, one, two or three tapholes. To order the correct basin configuration simply replace '\*' with 0TH, 1TH, 2TH or 3TH.



**600mm basin with overflow and ceramic console legs**  
W: 605 D: 525 H: 840  
Basin: ARC600\*  
Legs: ARC2



**900mm basin with overflow and ceramic console legs**  
W: 905 D: 550 H: 840  
Basin: ARC900\*  
Legs: ARC2



**1200mm basin with overflow and ceramic console legs**  
W: 1215 D: 560 H: 840  
Basin: ARC1200\*  
Legs: ARC2

Compatible wastes: ARCW18, ARCW19, ARCW14 (Add NKL for Nickel, CHR for Chrome). If a chrome overflow ring is required, A68 CHR can be ordered free of charge from your dealer. ARC600, ARC900 and ARC1200 basins are available with no, one, two or three tap holes. To order the correct basin configuration simply replace '\*' with 0TH, 1TH, 2TH or 3TH.

*NICKEL & CHROME BASIN STANDS*



600mm basin with overflow, stand & glass shelf

W: 605 D: 525 H: 840

Basin: ARC600\*  
Stand: ARC22 NKL



900mm basin with overflow, stand & glass shelf

W: 905 D: 550 H: 840

Basin: ARC900\*  
Stand: ARC23 NKL



1200mm double basin with double overflow, stand & glass shelf

W: 1215 D: 550 H: 840

Basin: ARC1200\*  
Stand: ARC24 NKL

Basin stands are constructed from stainless steel and have a nickel plate finish. Compatible wastes: ARCW18 NKL, ARCW19 NKL, ARCW14 NKL. If a chrome overflow ring is required, A68 CHR can be ordered free of charge from your dealer. ARC600, ARC900 and ARC1200 basins are available with no, one, two or three tap holes. To order the correct basin configuration simply replace '\*\*' with 0TH, 1TH, 2TH OT 3TH.



*NICKEL STAND*

*CHROME STAND*

Basin stands available in both Nickel (left) and Chrome (right)



600mm basin with overflow, stand & glass shelf

W: 605 D: 525 H: 840

Basin: ARC600\*  
Stand: ARC22 CHR



900mm basin with overflow, stand & glass shelf

W: 905 D: 550 H: 840

Basin: ARC900\*  
Stand: ARC23 CHR



1200mm double basin with double overflow, stand & glass shelf

W: 605 D: 525 H: 840

Basin: ARC1200\*  
Stand: ARC24 CHR

Basin stands are constructed from stainless steel and have a chrome plate finish. Compatible wastes: ARCW18 CHR, ARCW19 CHR, ARCW14 CHR. If a chrome overflow ring is required, A68 CHR can be ordered free of charge from your dealer. ARC600, ARC900 and ARC1200 basins are available with no, one, two or three tap holes. To order the correct basin configuration simply replace '\*\*' with 0TH, 1TH, 2TH OT 3TH.



The Arcade bicycle is inspiring and eye-catching which adds a unique character to your bathroom. Available with optional oak shelf.



## *ARCADE PASHLEY BICYCLE*



### **Pashley bicycle**

Bicycle

W: 1794 D: 600 H: 880

Code: BICY1

Basin

W: 840 D: 550

Code: ARC600

Oak shelf code: BICYSHLF (Optional)



WCs  
25  
YEARS  
GUARANTEE

# WCs

The widest range of traditional WC options to suit your installation and match the exact look you want.





*WC OPTIONS*

At Burlington we've created a range that's taller than average sanitaryware. Regal WC pans are 60mm higher than the standard option.



At 480mm high the taller WC pan ensures the knee angle remains at approximately 90 degrees whilst in use, which is the correct seating position. The taller WC provides a more comfortable use for taller people and the elderly whilst ensuring your WC is functional as well as beautiful too.

**nanoGLAZE**  
ceramic that stays cleaner

All WCs have a unique stay-clean NANO Glaze coating, creating an ultra-smooth surface, six times smoother than standard ceramic.

**WRAS®**  
Water Regulations Advisory Scheme

All Burlington close-coupled WCs are supplied with dual flush WRAS fittings.

**4½L (2½L)**

All Burlington WC fittings are factory set at 3L and 6L flush. They can be adjusted on site to flush at 2½L and 4½L.



**Lever or push button cistern**

Available with all Burlington Close-coupled, Low and Mid level WCs. Choose between the classic ceramic flush lever or the more contemporary flush front button.



**Lever**  
52cm Cistern (C1)  
44cm Cistern (C3)  
52cm Rear Entry Cistern (C30)



**Push Button**  
52cm Cistern (C2)  
44cm Cistern (C4)

**Feature levers**

Our feature cistern levers in Black or New Walnut are the perfect finishing touches and work beautifully with our other feature options such as WC seats, brassware and accessories.



**Black Lever**  
To add a Black Lever please add BLA to end of the code.



**Walnut Lever**  
To add a Walnut Lever please add WAL to end of the code.

*RIMLESS WCs*

Burlington bathrooms are the first traditional bathroom provider to introduce rimless technology to traditionally styled WCs. With the removal of the standard WC rim, this WC choice is exceptionally easy to keep clean. Its powerful flush covers the entire ceramic bowl, making it the most hygienic option. Available with both standard and slimline cisterns for standard height close-coupled, back-to-wall and medium level WCs.



Hygienic



Easy to clean



Powerful flush



Economic



## CLOSE-COUPLED WCs



**Standard CC WC with 520 lever cistern**  
 W: 520 D: 730 H: 780  
 Pan: P5  
 Lever Cistern: C1  
 Button Cistern: C2

**Standard CC WC with 440 lever cistern**  
 W: 440 D: 730 H: 780  
 Pan: P5  
 Lever Cistern: C3  
 Button Cistern: C4

**Regal Standard CC WC with 520 lever cistern**  
 W: 520 D: 730 H: 780  
 Pan: P12  
 Lever Cistern: C1  
 Button Cistern: C2

**Regal Standard CC WC with 440 lever cistern**  
 W: 440 D: 730 H: 780  
 Pan: P12  
 Lever Cistern: C3  
 Button Cistern: C4



**Rimless Standard CC WC with 520 lever cistern**  
 W: 520 D: 730 H: 780  
 Pan: P20  
 Lever Cistern: C1  
 Button Cistern: C2

**Rimless Standard CC WC with 440 lever cistern**  
 W: 440 D: 730 H: 780  
 Pan: P20  
 Lever Cistern: C3  
 Button Cistern: C4

**S Trap Standard CC WC with 520 lever cistern**  
 W: 520 D: 730 H: 780  
 Pan: P18  
 Lever Cistern: C1  
 Button Cistern: C2

**S Trap Standard CC WC with 440 lever cistern**  
 W: 440 D: 730 H: 780  
 Pan: P18  
 Lever Cistern: C3  
 Button Cistern: C4

### FEATURE LEVERS

Our feature cistern levers in Black or New Walnut are the perfect finishing touches and work beautifully with our other feature options such as WC seats, brassware and accessories.



To add a Black Lever please add BLA to end of the code.



To add a Walnut Lever please add WAL to end of the code.

### WC REAR ENTRY OPTIONS

Burlington cisterns are available with either bottom or back entry filling for flexible installation.

If you need to fill your cistern from the back, please order one of the below options.

**Back entry 520mm lever cistern**  
 C24

**Back entry 520mm deep lever cistern**  
 (This deep cistern increases the distance from pan outlet to the wall by 20mm)  
 C30



## LOW & MEDIUM LEVEL WCs



**Standard low level WC with 520 lever cistern**  
 W: 520 D: 740 H: 1075  
 Pan: P2  
 Lever Cistern: C1  
 Button Cistern: C2  
 Flush Pipe: T31 CHR



**Standard low level WC with 440 lever cistern**  
 W: 440 D: 740 H: 1075  
 Pan: P2  
 Lever Cistern: C3  
 Button Cistern: C4  
 Flush Pipe: T31 CHR



**Regal low level WC with 520 lever cistern**  
 W: 520 D: 740 H: 1075  
 Pan: P16  
 Lever Cistern: C1  
 Button Cistern: C2  
 Flush Pipe: T31 CHR



**Regal low level WC with 440 lever cistern**  
 W: 440 D: 740 H: 1075  
 Pan: P16  
 Lever Cistern: C3  
 Button Cistern: C4  
 Flush Pipe: T31 CHR



**Standard medium level WC with 520 lever cistern**  
 W: 520 D: 740 H: 1425  
 Pan: P5  
 Lever Cistern: C1  
 Button Cistern: C2  
 Flush Pipe: T33 CHR



**Standard medium level WC with 440 lever cistern**  
 W: 440 D: 740 H: 1425  
 Pan: P5  
 Lever Cistern: C3  
 Button Cistern: C4  
 Flush Pipe: T33 CHR

### FEATURE LEVERS

Our feature cistern levers in Black or New Walnut are the perfect finishing touches and work beautifully with our other feature options such as WC seats, brassware and accessories.



To add a Black Lever please add BLA to end of the code.



To add a Walnut Lever please add WAL to end of the code.



**S trap low level WC with 520 lever cistern**  
 W: 520 D: 740 H: 1075  
 Pan: P19  
 Lever Cistern: C1  
 Button Cistern: C2  
 Flush Pipe: T31 CHR



**S trap low level WC with 440 lever cistern**  
 W: 440 D: 740 H: 1075  
 Pan: P19  
 Lever Cistern: C3  
 Button Cistern: C4  
 Flush Pipe: T31 CHR

### WC REAR ENTRY OPTIONS

Burlington cisterns are available with either bottom or back entry filling for flexible installation.

If you need to fill your cistern from the back, please order one of the below options.

**Back entry 520mm lever cistern**  
 C24

**Back entry 520mm deep lever cistern**  
 (This deep cistern increases the distance from pan outlet to the wall by 20mm)  
 C30



**Regal medium level WC with 520 lever cistern**  
 W: 520 D: 740 H: 1425  
 Pan: P12  
 Lever Cistern: C1  
 Button Cistern: C2  
 Flush Pipe: T33 CHR



**Regal medium level WC with 440 lever cistern**  
 W: 440 D: 740 H: 1425  
 Pan: P12  
 Lever Cistern: C3  
 Button Cistern: C4  
 Flush Pipe: T33 CHR





## MEDIUM LEVEL WCs



Rimless medium level WC with 520 lever cistern  
W: 520 D: 740 H: 1425

Pan: P20  
Lever Cistern: C1  
Button Cistern: C2  
Flush Pipe: T33 CHR



Rimless medium level WC with 440 lever cistern  
W: 440 D: 740 H: 1425

Pan: P20  
Lever Cistern: C3  
Button Cistern: C4  
Flush Pipe: T33 CHR



S trap medium level WC with 520 lever cistern  
W: 520 D: 740 H: 1425

Pan: P18  
Lever Cistern: C1  
Button Cistern: C2  
Flush Pipe: T33 CHR



S trap medium level WC with 440 lever cistern  
W: 440 D: 740 H: 1425

Pan: P18  
Lever Cistern: C3  
Button Cistern: C4  
Flush Pipe: T33 CHR

### WC REAR ENTRY OPTIONS

Burlington cisterns are available with either bottom or back entry filling for flexible installation.

If you need to fill your cistern from the back, please order one of the below options.

**Back entry 520mm lever cistern**

C24

**Back entry 520mm deep lever cistern**

(This deep cistern increases the distance from pan outlet to the wall by 20mm)

C30

### CISTERN OPTIONS

A diverse range of WC options to suit your specific installation and desired aesthetic. Our feature cistern levers in Black or New Walnut are the perfect finishing touches and work beautifully with our other feature options such as WC seats, brassware and accessories.



#### Lever

52cm Cistern (C1)  
44cm Cistern (C2)  
52cm Rear Entry Cistern (C30)



#### Push Button

52cm Cistern (C2)  
44cm Cistern (C4)



#### Black Lever

To add a Black Lever please add BLA to end of the code.



#### Walnut Lever

To add a Walnut Lever please add WAL to end of the code.

**FEATURE PULL LEVERS**



To add a Black Pull Lever (C28S Cistern only) please add BLA to end of the code.



To add a Walnut Pull Lever (C28S Cistern only) please add WAL to end of the code.

**HIGH LEVEL WCs**



Standard high level WC with dual flush ceramic cistern

W: 520 D: 670 H: 2300-2380

Pan: P2  
Lever Cistern: C5  
Flush Pipe: T30 CHR



Standard high level WC with single flush ceramic cistern

W: 520 D: 670 H: 2300-2380

Pan: P2  
Lever Cistern: C28S  
Flush Pipe: T30 CHR



Standard high level WC with dual flush aluminium cistern

W: 430 D: 670 H: 2300-2380

Pan: P2  
Lever Cistern: T58 ALU  
Flush Pipe: T30 CHR



Standard high level WC with dual flush black aluminium cistern

W: 430 D: 670 H: 2300-2380

Pan: P2  
Lever Cistern: T60 BLA  
Flush Pipe: T30 CHR



Regal high level WC with dual flush black aluminium cistern

W: 430 D: 670 H: 2300-2380

Pan: P16  
Lever Cistern: T60 BLA  
Flush Pipe: T30 CHR



Regal high level WC with dual flush white aluminium cistern

W: 430 D: 670 H: 2300-2380

Pan: P16  
Lever Cistern: T59 WHI  
Flush Pipe: T30 CHR



S trap high level WC with dual flush ceramic cistern

W: 520 D: 670 H: 2300-2380

Pan: P19  
Lever Cistern: C5  
Flush Pipe: T30 CHR



S trap high level WC with single flush ceramic cistern

W: 520 D: 670 H: 2300-2380

Pan: P19  
Lever Cistern: C28S  
Flush Pipe: T30 CHR



Standard high level WC with dual flush white aluminium cistern

W: 430 D: 670 H: 2300-2380

Pan: P2  
Lever Cistern: T59 WHI  
Flush Pipe: T30 CHR



Regal high level WC with dual flush ceramic cistern

W: 520 D: 670 H: 2300-2380

Pan: P16  
Lever Cistern: C5  
Flush Pipe: T30 CHR



Regal high level WC with single flush ceramic cistern

W: 520 D: 670 H: 2300-2380

Pan: P16  
Lever Cistern: C28S  
Flush Pipe: T30 CHR



Regal high level WC with dual flush aluminium cistern

W: 430 D: 670 H: 2300-2380

Pan: P16  
Lever Cistern: T58 ALU  
Flush Pipe: T30 CHR



S trap high level WC with dual flush aluminium cistern

W: 430 D: 670 H: 2300-2380

Pan: P19  
Lever Cistern: T58 ALU  
Flush Pipe: T30 CHR



S trap high level WC with dual flush black aluminium cistern

W: 430 D: 670 H: 2300-2380

Pan: P19  
Lever Cistern: T60 BLA  
Flush Pipe: T30 CHR



S trap high level WC with dual flush white aluminium cistern

W: 430 D: 670 H: 2300-2380

Pan: P19  
Lever Cistern: T59 WHI  
Flush Pipe: T30 CHR



High-level pan with high level cistern and high-level angled flush pipe

Angled flush pipe can be ordered as an extra on all high level WCs

W: 905 D: 700 H: 2725

Pan: P2  
Lever Cistern: C5  
Flush Pipe: T34 CHR



## CHROME CISTERNS

For an additional lustrous finish, select the chrome cistern for low, medium and high level WCs. These work beautifully when paired with basins on chrome washstands, baths with chrome feet or the all new Balthazar bath with its stunning stainless steel finish. See page 22 or 124.



Standard low level WC  
with 440 chrome cistern  
W: 440 D: 740 H: 960-1130  
Pan: P2  
Lever Cistern: T71 CHR  
Flush Pipe: T31 CHR

Optional brackets T32 CHR see page 189



Standard medium level WC  
with 440 chrome cistern  
W: 440 D: 730 H: 1340-1425  
Pan: P5  
Lever Cistern: T71 CHR  
Flush Pipe: T33 CHR



Standard high level WC with  
440 chrome cistern  
W: 440 D: 670 H: 2320-2400  
Pan: P2  
Lever Cistern: T70 CHR  
Flush Pipe: T30 CHR

## BACK-TO-WALL WCs



**Rimless Back-to-wall**  
W: 370 D: 480 H: 420  
Pan: P21  
With a concealed cistern  
Code: F6CC



**Back-to-wall**  
W: 370 D: 480 H: 420  
Pan: P14  
With a concealed cistern  
Code: F6CC



**Regal back-to-wall**  
W: 370 D: 480 H: 480  
Pan: P15  
With a concealed cistern  
Code: F6CC



**Wall-hung**  
W: 400 D: 570  
Pan: P10  
Pair the wall-hung WC  
with a concealed cistern  
Code: F6CC

## BIDETS



**Wall-hung**  
W: 370 D: 500  
Bidet: P11



**Floor-standing**  
W: 400 D: 570 H: 400  
Bidet: P4



**Ceramic traps for converting P trap to S trap**  
Trap: C26



**Straight ceramic trap**  
Trap: C29

## WC ACCESSORIES

**nanoGLAZE**  
ceramic that stays cleaner

A cleaner toilet, by design and with NANO Glaze

We believe that the toilet bowl should still remain as clean as possible even with reduced flushing water and therefore engineer our toilet bowls to maintain the correct water area as previous British Standards and by coating the toilet bowl with NANO Glaze to make them exceptionally easy to keep clean.

## SEATS

Our choice of seats includes standard oak or mahogany, white carbamide (also available in a soft-close option), or soft close seats in a range of colours to match your furniture choice, black to pair with black cistern levers and accessories, beech for a classic look or walnut solid wood to match with our New walnut trims. Pair your low, medium or high level WC with our throne seats with ornate brackets.



**Soft-close sand seat (excluding handles)**  
Seat: S43



**Soft-close dark olive seat (excluding handles)**  
Seat: S44



**Soft-close matt white seat (excluding handles)**  
Seat: S45



**Soft-close classic grey seat (excluding handles)**  
Seat: S46



**Soft-close matt black seat (excluding handles)**  
Seat: S48



**Soft-close walnut solid wood seat (excluding handles)**  
Seat: S47

· NEW ·



**Soft-close beech solid wood seat (excluding handles)**  
Seat: S51



**Standard oak seat (excluding handles)**  
Seat: S11  
**Soft-close (excluding handles)**  
Seat: S16



**Standard gloss mahogany seat (excluding handles)**  
Seat: S12  
**Soft-close (excluding handles)**  
Seat: S17



**Standard white carbamide seat (not suitable for handles)**  
Seat: S13  
**Soft-close (not suitable for handles)**  
Seat: S18

· NEW ·



**Beech throne seat for high level WCs (not suitable for handles)**  
Seat: S53



**Oak throne seat for high level WCs (not suitable for handles)**  
Seat: S14

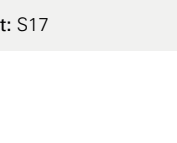

· NEW ·



**Walnut throne seat for high level WCs (not suitable for handles)**  
Seat: S52



**Mahogany throne seat for high level WCs (not suitable for handles)**  
Seat: S15

All seats are supplied without handles. To add seat handles use code  
Code: A51 CHR







**Open back close-coupled pan**  
 W: 500 D: 665 H: 885  
 Pan: ARC3\*  
 Lever Cistern: ARC5



**Full back-to-wall close-coupled pan and dual flush cistern**  
 W: 500 D: 670 H: 885  
 Pan: ARC4\*  
 Lever Cistern: ARC5



**Back-to-wall pan**  
 W: 365 D: 520 H: 400  
 Pan: ARC6\*



**Bidet with overflow**  
 W: 365 D: 520 H: 400  
 Bidet: ARC7\*



**Gloss white soft-close seat**  
 Seat: ARCS45 NKL



**Gloss black soft-close seat**  
 Seat: ARCS40 NKL



**Sand soft-close seat**  
 Seat: ARCS43 NKL



**Dark olive soft-close seat**  
 Seat: ARCS44 NKL



**Chrome seat handle**  
 Code: A51 CHR



**Nickel seat handle**  
 Code: ARCA51 NKL

All Arcade seats are supplied with Nickel soft-close hinges as standard. If you wish to swap to chrome hinges, please order A70 CHR which will be supplied free of charge. Handles are sold separately as shown to your left.

\* If you require a chrome cistern lever and screw covers, order A69 CHR free of charge from your dealer.

# ARCADE WCs



A range of beautifully traditional furniture solutions to add classic style and sophisticated British elegance to your bathroom. Choose from free-standing in either square or curved design, wall-hung, cloakroom or fully fitted options to create the most functional space to suit your individual needs.

# *FURNITURE*





## FURNITURE WITH INTELLIGENT DESIGN

Our furniture solutions are made from the finest materials and offer innovative features and smart details that not only make them suitable for the bathroom environment but built to last with a 10 year guarantee.



### FULLY FITTED FURNITURE

Unlike conventional fitted furniture, our units offer full floor to height storage providing increased space for all your bathroom cosmetics and accessories.

### CHOICE OF COLOUR

Four stunning and serene colourways across our entire range which can be carried through the bath panels and WC seats for a consistent and seamless look.

### MINERVA BASINS AND WORKTOPS

Minerva basins fit perfectly with your chosen furniture unit. Should you opt for a fitted furniture look, a Minerva worktop can be chosen to fit the length of your furniture units.

### 5 LAYERS OF PAINT

Each of our furniture pieces are prepared with 5 layers of primer featuring UV stabilisation to minimise colour fading from exposure to sunlight. The painted top coat is then applied for a glorious depth of colour.



### ROUTINE CLEANING

Minerva® does not require any specialist cleaning regimes, most dirt and light residue will easily wipe off with a damp cloth and soapy water. The work surface should then be rinsed with clean water and wiped dry. Persistent marks can be removed by using a mild abrasive cleaner, but harsh scouring powders should be avoided.



### STAINING

Minerva®, unlike marble and granite, is not porous and will resist most household chemicals including alcohol and cosmetics, however, some chemicals and strong dyes can cause damage and discolouration. If spillage occurs, wipe off immediately and rinse the area thoroughly.



### TAP HOLES

Minerva® worktops are supplied with an integrated bowl with overflow, and no tap holes. Tap holes are drilled by the installer in the required position and configuration. A template is provided with the Minerva® tops indicating tap hole positions and sizes.



### MINOR SCRATCHING

Scratches to the work surface will be more evident on darker colours. Any minor scratches can be removed using a woven abrasive pad and other items in the care kit.



### MINERVA® CARE KIT

To restore your Minerva® work top to its original best use the Care Kit to buff out all tiny scratches and scuffs. The kit contains all the sanding / buffing materials and liquids required.



### CRAFTED SPECIFICALLY FOR BATHROOMS

The plinths of the free-standing furniture are crafted from a waterproof high density material - providing extra protection and giving peace of mind that wet floors will not lead to damage.



### DIMENSIONS & TECHNICAL DRAWINGS

Dimensional drawings and technical details are shown at [burlingtonbathrooms.com/furniture](http://burlingtonbathrooms.com/furniture)



## MINERVA WORKTOPS

Minerva worktops offer superior strength with a beautiful finish. Available from stock in either pristine White, elegant Carrara White or opulent Black Granite. Why not choose from our other 11 unique decor options, available to order with longer custom delivery times for the ultimate personalised look. Please ask your retailer for details on the price of the 11 additional finishes.



White



Carrara White



Black Granite

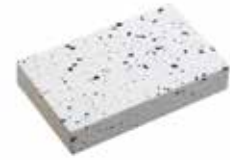

Ice Blue



Desert Rock



Fossil



Peak Stone



Nimbus Grey



Amazonia Brown



Ice Crystal



Copper Fleck



Sparkling White



Caramel Crunch



Grey Crystal



Minerva® care kit  
Code: BCARE



Minerva® Joint Kit  
White: MVCA  
Carrara White: MVCA  
Carrara Black: MVCA

## PAINT YOUR OWN

Should you wish, our Matt White furniture is supplied ready for you to paint, so you can transform your entire bathroom into your individual colour scheme. We've chosen some Farrow & Ball colours as suggestions displayed below. We recommend using a water based primer before an egg shell paint finish for the best effect.



Pelt



Red Earth



Brassica



Vert De Terre



Cook's Blue



Cinder Rose



## FREE-STANDING CLOAKROOM VANITY UNIT



Edwardian cloakroom basin & free-standing rectangular cloakroom vanity unit

W: 510 D: 310 H: 760

Matt White: FC11W + B8  
Sand: FC11S + B8  
Dark Olive: FC11O + B8  
Classic Grey: FC11G + B8



Edwardian 560mm basin & free-standing rectangular cloakroom vanity unit

W: 560 D: 470 H: 760

Matt White: FC12W + B4  
Sand: FC12S + B4  
Dark Olive: FC12O + B4  
Classic Grey: FC12G + B4



Classic 510mm basin & free-standing 500mm square cloakroom vanity unit

W: 510 D: 500 H: 760

Matt White: FC8W + B20  
Sand: FC8S + B20  
Dark Olive: FC8O + B20  
Classic Grey: FC8G + B20



Corner quattrocass basin & free-standing corner cloakroom vanity unit

Right hand only. Handles are supplied fitted.

W: 445 D: 445 H: 785

Matt White: FC7W + FC7BB  
Sand: FC7S + FC7BB  
Dark Olive: FC7O + FC7BB  
Classic Grey: FC7G + FC7BB

### CLOAKROOM BASINS

Our cloakroom furniture units are available with corresponding basins in Edwardian or Classic cloakroom styles. See page 70 for the Edwardian cloakroom basin or page 53 for the Classic 510mm basin.



510mm Edwardian rectangular basin

W: 510 D: 320

Basin: B8



560mm Edwardian basin

W: 560 D: 470

Basin: B4



510mm Classic square basin

W: 510 D: 580

Basin: B20

Nickel handles sold as individual product Code: A56 NKL

650 FREE-STANDING UNIT



Free-standing 650 vanity unit with doors & Classic 650 basin for standard waste & overflow  
 W: 670 D: 580 H: 930  
 Matt White: FF8W + B15  
 Sand: FF8S + B15  
 Dark Olive: FF8O + B15  
 Classic Grey: FF8G + B15



Free-standing 650 vanity unit with doors & Classic 650 basin for integrated waste & overflow  
 W: 670 D: 580 H: 930  
 Matt White: FF8W + B14  
 Sand: FF8S + B14  
 Dark Olive: FF8O + B14  
 Classic Grey: FF8G + B14



Free-standing 650 vanity unit with doors & Minerva® White with vanity bowl  
 W: 670 D: 580 H: 850-930  
 Matt White: FF8W + BW66  
 Sand: FF8S + BW66  
 Dark Olive: FF8O + BW66  
 Classic Grey: FF8G + BW66

650 FREE-STANDING UNIT



Free-standing 650 vanity unit with drawers & Classic 650 basin for standard waste & overflow  
 W: 670 D: 580 H: 930  
 Matt White: FF9W + B15  
 Sand: FF9S + B15  
 Dark Olive: FF9O + B15  
 Classic Grey: FF9G + B15



Free-standing 650 vanity unit with drawers & Classic 650 basin for integrated waste & overflow  
 W: 670 D: 580 H: 930  
 Matt White: FF9W + B14  
 Sand: FF9S + B14  
 Dark Olive: FF9O + B14  
 Classic Grey: FF9G + B14



Free-standing 650 vanity unit with drawers & Minerva® White with vanity bowl  
 W: 670 D: 580 H: 850-930  
 Matt White: FF9W + BW66  
 Sand: FF9S + BW66  
 Dark Olive: FF9O + BW66  
 Classic Grey: FF9G + BW66



Free-standing 650 vanity unit with doors & Minerva® Carrara basin White vanity bowl  
 W: 670 D: 580 H: 850-930  
 Matt White: FF8W + BC66  
 Sand: FF8S + BC66  
 Dark Olive: FF8O + BC66  
 Classic Grey: FF8G + BC66



Free-standing 650 vanity unit with doors & Minerva® Black Granite with vanity bowl  
 W: 670 D: 580 H: 850-930  
 Matt White: FF8W + BB66  
 Sand: FF8S + BB66  
 Dark Olive: FF8O + BB66  
 Classic Grey: FF8G + BB66

**SOFT-CLOSE DOORS & DRAWERS**

All of our units feature soft-close doors and drawers with wide opening spaces for maximum capacity. Add internal lighting to illuminate your vanity unit when movement is detected.



Free-standing 650 vanity unit with drawers & Minerva® Carrara basin White vanity bowl  
 W: 670 D: 580 H: 850-930  
 Matt White: FF9W + BC66  
 Sand: FF9S + BC66  
 Dark Olive: FF9O + BC66  
 Classic Grey: FF9G + BC66



Free-standing 650 vanity unit with drawers & Minerva® Black Granite with vanity bowl  
 W: 670 D: 580 H: 850-930  
 Matt White: FF9W + BB66  
 Sand: FF9S + BB66  
 Dark Olive: FF9O + BB66  
 Classic Grey: FF9G + BB66

**MINERVA TAP HOLES**

Minerva basins are supplied with an integrated bowl with overflow and no tap holes. Tap holes are drilled by the installer in the required position and configuration. A template is provided with the Minerva tops indicating tap hole positions and size.



Nickel handles sold as individual product  
 Code: A56 NKL

Nickel handles sold as individual product  
 Code: A56 NKL



## 650 WALL-HUNG UNIT



Wall-hung 650 vanity unit with single drawer & Classic 650 basin for standard waste & overflow  
 W: 660 D: 580 H: 580  
 Matt White: FW1W + B15  
 Sand: FW1S + B15  
 Dark Olive: FW1O + B15  
 Classic Grey: FW1G + B15



Wall-hung 650 vanity unit with single drawer & Classic 650 basin for integrated waste & overflow  
 W: 660 D: 580 H: 580  
 Matt White: FW1W + B14  
 Sand: FW1S + B14  
 Dark Olive: FW1O + B14  
 Classic Grey: FW1G + B14



Wall-hung 650 vanity unit with single drawer & Minerva® White with vanity bowl  
 W: 670 D: 550 H: 510-590  
 Matt White: FW1W + BW66  
 Sand: FW1S + BW66  
 Dark Olive: FW1O + BW66  
 Classic Grey: FW1G + BW66



Wall-hung 650 vanity unit with single drawer & Minerva® Carrara White with vanity bowl  
 W: 670 D: 550 H: 510-590  
 Matt White: FW1W + BC66  
 Sand: FW1S + BC66  
 Dark Olive: FW1O + BC66  
 Classic Grey: FW1G + BC66



Wall-hung 650 vanity unit with single drawer & Minerva® Black Granite with vanity bowl  
 W: 670 D: 550 H: 510-590  
 Matt White: FW1W + BB66  
 Sand: FW1S + BB66  
 Dark Olive: FW1O + BB66  
 Classic Grey: FW1G + BB66

Nickel handles sold as individual product  
 Code: A56 NKL



1300 FREE-STANDING UNIT



Free-standing 1300 vanity unit with doors & Minerva® White with double vanity bowl  
W: 1300 D: 550 H: 850-930  
Matt White: FC9W + BW12  
Sand: FC9S + BW12  
Dark Olive: FC9O + BW12  
Classic Grey: FC9G + BW12



Free-standing 1300 vanity unit with doors & Minerva® Carrara White with double vanity bowl  
W: 1300 D: 550 H: 850-930  
Matt White: FC9W + BC12  
Sand: FC9S + BC12  
Dark Olive: FC9O + BC12  
Classic Grey: FC9G + BC12



Free-standing 1300 vanity unit with doors & Minerva® Carrara Black Granite with double vanity bowl  
W: 1300 D: 550 H: 850-930  
Matt White: FC9W + BB12  
Sand: FC9S + BB12  
Dark Olive: FC9O + BB12  
Classic Grey: FC9G + BB12



Free-standing 1300 vanity unit with drawers & Minerva® White with double vanity bowl  
W: 1300 D: 550 H: 850-930  
Matt White: FC10W + BW12  
Sand: FC10S + BW12  
Dark Olive: FC10O + BW12  
Classic Grey: FC10G + BW12



Free-standing 1300 vanity unit with drawers & Minerva® Carrara White with double vanity bowl  
W: 1300 D: 550 H: 850-930  
Matt White: FC10W + BC12  
Sand: FC10S + BC12  
Dark Olive: FC10O + BC12  
Classic Grey: FC10G + BC12



Free-standing 1300 vanity unit with drawers & Minerva® Carrara Black Granite with double vanity bowl  
W: 1300 D: 550 H: 850-930  
Matt White: FC10W + BB12  
Sand: FC10S + BB12  
Dark Olive: FC10O + BB12  
Classic Grey: FC10G + BB12



## 1340 CURVED VANITY UNIT



Free-standing 1340 curved vanity unit with doors & Minerva® White with vanity bowl  
 W: 1340 D: 550 H: 850-930  
 Matt White: FC1W + BW13  
 Sand: FC1S + BW13  
 Dark Olive: FC1O + BW13  
 Classic Grey: FC1G + BW13



Free-standing 1340 curved vanity unit with doors & Minerva® Carrara White with vanity bowl  
 W: 1340 D: 550 H: 850-930  
 Matt White: FC1W + BC13  
 Sand: FC1S + BC13  
 Dark Olive: FC1O + BC13  
 Classic Grey: FC1G + BC13



Free-standing 1340 curved vanity unit with doors & Minerva® Carrara Black Granite with vanity bowl  
 W: 1340 D: 550 H: 850-930  
 Matt White: FC1W + BB13  
 Sand: FC1S + BB13  
 Dark Olive: FC1O + BB13  
 Classic Grey: FC1G + BB13



Free-standing 1340 curved vanity unit with doors and drawers & Minerva® White with vanity bowl  
 W: 1340 D: 550 H: 850-930  
 Matt White: FC4W + BW13  
 Sand: FC4S + BW13  
 Dark Olive: FC4O + BW13  
 Classic Grey: FC4G + BW13



Free-standing 1340 curved vanity unit with doors and drawers & Minerva® Carrara White with vanity bowl  
 W: 1340 D: 550 H: 850-930  
 Matt White: FC4W + BC13  
 Sand: FC4S + BC13  
 Dark Olive: FC4O + BC13  
 Classic Grey: FC4G + BC13



Free-standing 1340 curved vanity unit with doors and drawers & Minerva® Carrara Black Granite with vanity bowl  
 W: 1340 D: 550 H: 850-930  
 Matt White: FC4W + BB13  
 Sand: FC4S + BB13  
 Dark Olive: FC4O + BB13  
 Classic Grey: FC4G + BB13

## 1340 CURVED WALL UNIT



Curved 1340 wall-hung vanity unit & Minerva® White with vanity bowl  
 W: 1340 D: 550 H: 510  
 Matt White: FW4W + BW13  
 Sand: FW4S + BW13  
 Dark Olive: FW4O + BW13  
 Classic Grey: FW4G + BW13



Curved 1340 wall-hung vanity unit & Minerva® Carrara White with vanity bowl  
 W: 1340 D: 550 H: 510  
 Matt White: FW4W + BC13  
 Sand: FW4S + BC13  
 Dark Olive: FW4O + BC13  
 Classic Grey: FW4G + BC13



Curved 1340 wall-hung vanity unit & Minerva® Black Granite with vanity bowl  
 W: 1340 D: 550 H: 510  
 Matt White: FW4W + BB13  
 Sand: FW4S + BB13  
 Dark Olive: FW4O + BB13  
 Classic Grey: FW4G + BB13

## 980 CURVED VANITY UNIT



Free-standing 980 curved left-handed vanity unit with doors & Minerva® White with left-handed vanity bowl

W: 980 D: 550 H: 850-930

Matt White: FC2W + BW98L  
Sand: FC2S + BW98L  
Dark Olive: FC2O + BW98L  
Classic Grey: FC2G + BW98L



Free-standing 980 curved left-handed vanity unit with doors & Minerva® Carrara White with left-handed vanity bowl

W: 980 D: 550 H: 850-930

Matt White: FC2W + BC98L  
Sand: FC2S + BC98L  
Dark Olive: FC2O + BC98L  
Classic Grey: FC2G + BC98L



Free-standing 980 curved left-handed vanity unit with doors & Minerva® Black Granite with left-handed vanity bowl

W: 980 D: 550 H: 850-930

Matt White: FC2W + BB98L  
Sand: FC2S + BB98L  
Dark Olive: FC2O + BB98L  
Classic Grey: FC2G + BB98L

## 980 CURVED WALL UNIT



Wall-hung 980 curved left-handed vanity unit with doors & Minerva® White with left-handed vanity bowl

W: 980 D: 550 H: 510-590

Matt White: FW5W + BW98L  
Sand: FW5S + BW98L  
Dark Olive: FW5O + BW98L  
Classic Grey: FW5G + BW98L



Wall-hung 980 curved left-handed vanity unit with doors & Minerva® Carrara White with left-handed vanity bowl

W: 980 D: 550 H: 510-590

Matt White: FW5W + BC98L  
Sand: FW5S + BC98L  
Dark Olive: FW5O + BC98L  
Classic Grey: FW5G + BC98L



Wall-hung 980 curved left-handed vanity unit with doors & Minerva® Black Granite with left-handed vanity bowl

W: 980 D: 550 H: 510-590

Matt White: FW5W + BB98L  
Sand: FW5S + BB98L  
Dark Olive: FW5O + BB98L  
Classic Grey: FW5G + BB98L



Free-standing 980 curved right-handed vanity unit with doors & Minerva® Carrara White with right-handed vanity bowl

W: 980 D: 550 H: 850-930

Matt White: FC3W + BW98R  
Sand: FC3S + BW98R  
Dark Olive: FC3O + BW98R  
Classic Grey: FC3G + BW98R



Free-standing 980 curved right-handed vanity unit with doors & Minerva® White with right-handed vanity bowl

W: 980 D: 550 H: 850-930

Matt White: FC3W + BC98R  
Sand: FC3S + BC98R  
Dark Olive: FC3O + BC98R  
Classic Grey: FC3G + BC98R



Free-standing 980 curved right-handed vanity unit with doors & Minerva® Black Granite with right-handed vanity bowl

W: 980 D: 550 H: 850-930

Matt White: FC3W + BB98R  
Sand: FC3S + BB98R  
Dark Olive: FC3O + BB98R  
Classic Grey: FC3G + BB98R



Wall-hung 980 curved right-handed vanity unit with doors & Minerva® White with right-handed vanity bowl

W: 980 D: 550 H: 510-590

Matt White: FW6W + BW98R  
Sand: FW6S + BW98R  
Dark Olive: FW6O + BW98R  
Classic Grey: FW6G + BW98R



Wall-hung 980 curved right-handed vanity unit with doors & Minerva® Carrara White with right-handed vanity bowl

W: 980 D: 550 H: 510-590

Matt White: FW6W + BC98R  
Sand: FW6S + BC98R  
Dark Olive: FW6O + BC98R  
Classic Grey: FW6G + BC98R



Wall-hung 980 curved right-handed vanity unit with doors & Minerva® Black Granite with right-handed vanity bowl

W: 980 D: 550 H: 510-590

Matt White: FW6W + BB98R  
Sand: FW6S + BB98R  
Dark Olive: FW6O + BB98R  
Classic Grey: FW6G + BB98R



## FITTED FURNITURE



600mm mirrored double door wall unit  
W: 600 D: 150 H: 750  
Sand: F6MS



2x 600mm double door wall unit  
W: 980 D: 550 H: 510-590  
Sand: F6WS



Soft-close seat chrome hinge, Sand  
Sand: S43



300mm Tall two door base unit  
W: 300 D: 300 H: 1910  
Matt White: F3TS



600mm basin base unit for semi recessed basin with semi recessed 580mm basin base unit  
W: 600 D: 300 H: 850 (unit)  
W: 575 D: 470 (basin)  
Sand: F6BS  
Basin: B12



600mm double door base unit  
W: 600 D: 150 H: 750  
Sand: F60S



600mm back-to-wall WC unit with lever flush cistern WC unit  
W: 600 D: 300 H: 850 (unit)  
W: 365 D: 480 H: 420 (WC)  
Matt White: W60S  
Pan: P14



Minerva® white 1200mm worktop  
W: 1200 D: 305 H: 25  
White: BW305



Minerva® Joint Kit, White  
Code: MVCA

WALL FURNITURE



600mm double door wall unit  
W: 600 D: 150 H: 750  
Code: F6WW\*



300mm single door wall unit  
W: 300 D: 150 H: 750  
Code: F3WW\*



600mm mirrored double door wall unit  
W: 600 D: 150 H: 750  
Code: F6M\*



300mm mirrored single door wall unit  
W: 300 D: 150 H: 750  
Code: F3M\*



Soft-close matt white seat  
(Excluding handles)  
White Seat: S45  
Grey Seat: S46  
Olive Seat: S44  
Sand Seat: S43  
Handle: A51CHR



Minerva® white 1200mm worktop  
W: 1200 D: 305 H: 25  
White: BW305



Minerva® Carrara white 1200mm worktop  
W: 1200 D: 305 H: 25  
Carrara White: BC305



Minerva® Carrara black 1200mm worktop  
W: 1200 D: 305 H: 25  
Carrara Black: BB305



600mm basin base unit for semi recessed basin  
W: 600 D: 580 H: 1950  
Unit: F6B\*  
Basin: B12



600mm back-to-wall WC unit with lever and back-to-wall pan  
W: 600 D: 480 H: 850  
Unit: W60\*  
Pan: P14



600mm back-to-wall WC unit with lever and regal back-to-wall pan  
W: 600 D: 480 H: 850  
Unit: W60\*  
Pan: P15

\*All furniture units are available in Matt White, Sand, Dark Olive or Classic Grey. To order the correct colour simply replace '\*\*' with W, S, O or G.



Framed 600 mirror with LED illuminations  
W: 600 D: 40 H: 750  
Code: M6M\*



Framed 900 mirror with LED illuminations  
W: 900 D: 40 H: 750  
Code: M9M\*

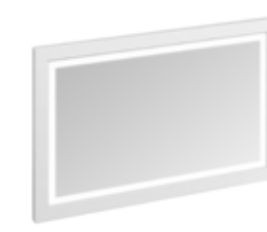

Framed 1200 mirror with LED illuminations  
W: 1200 D: 40 H: 750  
Code: M12M\*

\*All furniture units are available in Matt White, Sand, Dark Olive or Classic Grey. To order the correct colour simply replace '\*\*' with W, S, O or G.



600mm wall-hung WC unit with lever flush cistern WC unit  
W: 600 D: 480 H: 850  
Matt White: W60\*  
Pan: P10  
Steel Frame: W33A



600mm double door base unit  
W: 600 D: 300 H: 850  
Code: F60\*



300mm single door base unit  
W: 300 D: 300 H: 850  
Code: F30\*



300mm tall two door base unit  
W: 300 D: 300 H: 1910  
Code: F3T\*



Framed 600 mirror  
W: 600 D: 40 H: 750  
Code: M6O\*



Framed 900 mirror  
W: 900 D: 40 H: 750  
Code: M9O\*



Framed 1200 mirror  
W: 1200 D: 40 H: 750  
Code: M12O\*



Plumbing cover in matt grey  
W: 300 D: 150 H: 750  
Code: X02G



# ARUNDEL BATH



# LONDON BATH



Luxury bath grips  
Code: R30

Arundel bath 1700 x 700 with adjustable legs and matching panels  
W: 700 L: 1700 H: 595

Matt White: E28 + E24FW + E25EW  
Sand: E28 + E24FS + E25ES  
Dark Olive: E28 + E24FO + E25EO  
Classic Grey: E28 + E24FG + E25EG

For baths without panels see page 129

Arundel bath 1700 x 750 with adjustable legs and matching panels  
W: 750 L: 1700 H: 595

Matt White: E30 + E24FW + E26EW  
Sand: E30 + E24FS + E26ES  
Dark Olive: E30 + E24FO + E26EO  
Classic Grey: E30 + E24FG + E26EG

For baths without panels see page 129



Standard bath grips  
Code: R37



London bath with curved surround including overflow & waste in matt white  
W: 850 L: 1800 H: 600

Matt White: E22W  
Sand: E22S  
Dark Olive: E22O  
Classic Grey: E22G

London back-to-wall bath with curved surround including overflow & waste in matt white  
W: 950 D: 1800 H: 600

Matt White: E23W  
Sand: E23S  
Dark Olive: E23O  
Classic Grey: E23G

London bath is supplied with overflow and fitted waste

For bath panels see page 129

# BATHS



Beautiful free-standing baths in a range of designs crafted with either TSFR (twin skinned fibre re-inforced acrylic) for superior strength or ClearStone for the epitome of luxury. Choose from soaking tubs, elegant roll top baths with a choice of feet in six styles and three colours or our double-ended or showering baths for flexibility of use.





*BALTHAZAR*

· NEW ·



**Balthazar double-ended bath**  
L: 1675 W: 761 H: 711  
Stainless steel: N25CS  
Black: N25CSB  
White: N25CSW

**Weight empty**  
111kg  
**Displaced capacity**  
164L  
**Material**  
Clearstone

**Finish**  
Stainless steel. White and Black baths are stainless steel with a powder coated surround.  
**Compatible wastes**  
CW3, CW11

**Tap hole options**  
Not suitable for rim-mounted taps  
**Overflow**  
Pre-drilled

*ADMIRAL  
DOUBLE-ENDED BATH*



**Admiral double-ended  
1650 / 1800mm bath**  
1650mm L: 1640 W: 705 H: 710  
1800mm L: 1775 W: 890 H: 750  
1650mm code: ET5C  
1800mm code: ET6C

**Weight empty**  
1650mm 48kg  
1800mm 60kg  
**Displaced capacity**  
1650mm 99L  
1800mm 175L  
**Material**  
Acrylic

**Compatible wastes**  
CW3, W4, CW6  
**Tap hole options**  
Not suitable for rim-mounted taps  
**Overflow**  
Pre-drilled

## *BRINDLEY DOUBLE-ENDED BATH*



**Brindley double-ended bath with surround**  
L: 1700 W: 750 H: 620  
Code: E5+E12

**Weight empty**  
36kg  
**Displaced capacity**  
180L  
**Material**  
Acrylic

**Compatible wastes**  
CW2, W3  
**Tap hole options**  
Not suitable for rim-mounted taps  
**Overflow**  
Supplied with template, undrilled

## *LONDON ROUND DOUBLE-ENDED BATH*



**London round double-ended bath**  
L: 1800 W: 850 H: 640  
Code: E18

**Weight empty**  
52g  
**Displaced capacity**  
200L  
**Material**  
Acrylic

**Compatible wastes**  
Pre fitted  
**Tap hole options**  
Not suitable for rim-mounted taps  
**Overflow**  
Pre-drilled



## EMPEROR SLIPPER BATH



Emperor slipper bath  
L: 1530 W: 725 H: 780  
Code: ET13B

Weight empty  
38kg  
Displaced capacity  
242L  
Material  
Acrylic

Compatible wastes  
CW2, CW3, W4, CW6, W21  
Tap hole options  
Not suitable for rim-mounted taps  
Overflow  
Supplied with template, undrilled

## ARUNDEL BATH

Arundel 700 / 750mm bath  
700mm L: 1700 W: 700 H: 580  
750mm L: 1700 W: 750 H: 580  
700mm code: E28  
750mm code: E30

Weight emptied  
700mm 24kg  
750mm 25kg  
Displaced capacity  
700mm 108L  
750mm 125L  
Material  
Acrylic with Cleargreen reinforcement

Compatible wastes  
W3  
Compatible bathscreens  
C9, C10  
Compatible bath grips  
R30, R37  
Tap hole options  
Undrilled  
Overflow  
Pre-drilled



Arundel 700/750 bath end panels  
700mm W: 700 H: 540  
750mm W: 750 H: 540  
700mm code: E25E\*  
750mm code: E26E\*

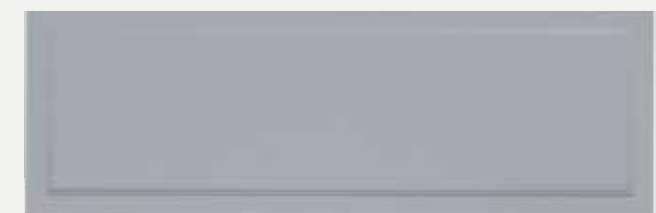

Arundel 1700 bath side panel  
W: 1700 H: 540  
Code: E24F\*

\* To order bath panels in your chosen colour, replace \* with S for Sand, W for White, G for Classic Grey and O for Dark Olive.

*AVANTGARDE BATH*

**Avantgarde bath**  
L: 1700 W: 750 H: 630  
Code: T12D

**Weight empty**  
43kg  
**Displaced capacity**  
158L  
**Material**  
TSFR Double Acrylic

**Compatible wastes**  
CW2, CW3, W4, CW6, W21  
**Tap hole options**  
0, 1, 2 (supplied with  
template, undrilled)  
**Overflow**  
Supplied with template, undrilled  
**Feet options**  
See page 138

*BATEAU  
DOUBLE-ENDED BATH*

**Bateau double-ended  
1700mm bath**  
L: 1640 W: 700 H: 720  
Code: T10F

**Weight empty**  
42kg  
**Displaced capacity**  
169L  
**Material**  
TSFR Double Acrylic

**Compatible wastes**  
CW3, W4, CW6, W21  
**Tap hole options**  
Not suitable for rim-mounted taps  
**Overflow**  
Pre-drilled  
**Feet options**  
See page 138



## WINDSOR DOUBLE-ENDED BATH



Windsor double-ended  
1500 / 1700mm bath  
1500mm L: 1500 W: 750 H: 630  
1700mm L: 1700 W: 750 H: 620  
1500mm code: E4  
1700mm code: E3

Weight empty  
1500mm 45kg  
1700mm 45kg  
Displaced capacity  
1500mm 115L  
1700mm 130L  
Material  
TSFR Double Acrylic

Compatible wastes  
CW2, CW3, W4, W21  
Tap hole options  
0, 1, 2 (supplied with  
template, undrilled)  
Overflow  
Supplied with template, undrilled  
Feet options  
See page 138

## BUCKINGHAM SLIPPER BATH



Buckingham 1500mm  
slipper bath  
L: 1500 W: 740 H: 620  
Code: E6

Weight empty  
39kg  
Displaced capacity  
85L  
Material  
TSFR Double Acrylic

Compatible wastes  
CW2, CW3, W4, W21  
Tap hole options  
0, 1, 2 (supplied with  
template, undrilled)  
Overflow  
Supplied with template, undrilled  
Feet options  
See page 138

## HAREWOOD SLIPPER BATH



**Harewood 1700mm  
slipper bath**  
L: 1690 W: 730 H: 770  
Code: E1

**Weight empty**  
48kg  
**Displaced capacity**  
125L  
**Material**  
TSFR Double Acrylic

**Compatible wastes**  
CW2, CW3, W4, W21  
**Tap hole options**  
0, 1, 2 (supplied with  
template, undrilled)  
**Overflow**  
Supplied with template, undrilled  
**Feet options**  
See page 138

## BLENHEIM SINGLE-ENDED BATH



**Blenheim single-  
ended bath**  
L: 1690 W: 750 H: 640  
Code: E2

**Weight empty**  
45kg  
**Displaced capacity**  
115L  
**Material**  
TSFR Double Acrylic

**Compatible wastes**  
CW2, CW3, W4, W21  
**Tap hole options**  
0, 1, 2 (supplied with  
template, undrilled)  
**Overflow**  
Supplied with template, undrilled  
**Feet options**  
See page 138



## HAMPTON RIGHT & LEFT-HANDED BATH

Left-handed



Right-handed



Hampton 1500 / 1700 right and left-handed bath

1500mm L: 1500 W: 750 H: 610  
1700mm L: 1690 W: 750 H: 630

1500 Right: E21

1500 Left: E20

1700 Right: E14

1700 Left: E13

Compatible wastes  
W4

Material  
TSFR Double Acrylic

Compatible bath grips  
R30, R37

Tap hole options  
Undrilled

Overflow  
Pre-drilled

Feet options  
See page 138



Single bathscreen

Bathscreens

Single W: 850 H: 1450

Single code: C9



Bathscreen with access panel

Bathscreens

Access W: 850 H: 1450

Access code: C10

## SHOWERING BATH

For those with a slightly smaller space wanting to make the most out of their bathrooms, why not choose the Hampton showering bath, offering flexibility and versatility to those wanting to bathe and shower. Available in two sizes with both left and right-handed options.



## LUXURY BATH FEET



### Claw feet

Chrome: L1C  
White: L1W  
Black: L1B

### Arc feet

Chrome: L2C  
White: L2W  
Black: L2B

### Classic feet

Chrome: L3C  
White: L3W  
Black: L3B

## STANDARD BATH FEET



### Traditional feet

Chrome: E11 CHR  
White: E11 WHI  
Black: E11 BLA

### Classical feet

Chrome: E10 CHR  
White: E10 WHI  
Black: E10 BLA

### Period feet

Chrome: E9 CHR  
White: E9 WHI  
Black: E9 BLA

## STAND PIPES & SHROUDS



### Stand pipes including horizontal support bar

W: 280 D: 100 H: 600  
Code: W7

These are for use with baths where fittings are not rim or wall-mounted (water runs through the pipes). Can be used with deck-mounted taps.



### Decorative shrouds

W: 70 D: 70 H: 710  
Code: W6

These are for use with baths with rim-mounted fittings and can be used with deck-mounted taps.





# ARCADE BATHS

## ALBANY FREE-STANDING NATURAL STONE BATH



### Albany free-standing natural stone bath

L: 1690 W: 800 H: 570

Code: ARC21

Weight empty  
132kg

Displaced capacity  
256L

Material  
Natural Stone

Tap hole options  
Not suitable for rim-  
mounted taps

Overflow  
Integrated overflow  
(excluded the bath waste)

Compatible Wastes  
CW1 and CW3



### STAND PIPES

The Albany is not suitable for rim-mounted taps. Instead, pair elegant bath shower mixers with stand pipes (water runs through the pipes) in either matching chrome or nickel to add an air of luxury to your bathroom.

### Floor-mounted exposed water pipes with support bar

Nickel: ARCW7 NKL  
Chrome: ARCW7 CHR



# BRASSWARE

Burlington brassware can be customised with a choice of 4 tap heads; Claremont, Birkenhead, Anglesey and Kensington. In addition, Burlington is the first British Traditional designed range that enables water savings despite varying water pressures. We supply every tap with two Neoperl devices: A flow straightener, which is for use with low water pressures and an aerator, which is for use with high water pressures.



**Normal tap**  
Water flow in a normal traditional tap.



**Low pressure**  
Low pressure water flow with a Burlington tap using a flow straightener.



**High pressure**  
High pressure water flow with a Burlington tap using an aerator.

Our taps are designed to deliver the following maximum flows of water, regardless of the incoming water pressure:

**Basin taps:** 13L per minute  
**Bath tap:** 14L per minute  
**Bath shower mixer:** 22L per minute



**Swivelling spouts**  
All our bath fillers and bath shower mixer spouts swivel - so you don't have the spout in your way when you shower.



**Angled mixers**  
All our bath fillers and bath shower mixers are available in an 'angled' version.

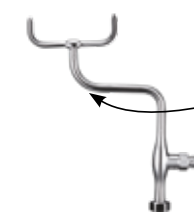

**S adjuster**  
The S adjuster allows the telephone handset to be positioned over the bath. The bath shower mixer can be installed with or without the 'S adjuster'.

**CLAREMONT    BIRKENHEAD    ANGLESEY    KENSINGTON**



add CL to start of code



add BI to start of code



add AN to start of code



add KE to start of code

**NORMAL SPOUT**



The underside of a bath spout of a normal, traditional bath tap.

**BURLINGTON SPOUT**



The underside of a Burlington bath tap with a Neoperl aerator.

**BURLINGTON TAP OPTIONS**

Each of the tap heads are available with Black ceramic indices as opposed to White.



Claremont



Anglesey



Birkenhead



Kensington



Kensington

Our Kensington tap is now available in Walnut. See page 146 for more details.



**Bridge mixers**  
Our bridge basin mixer has a swivelling spout and allows you to have mixed hot & cold water, whilst using a two taphole configuration.



Swivels

- Straight down
- 90° left or right
- Straight up
- Normal basin mixer
- Off

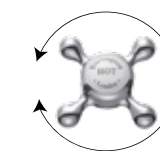

Traditional screw-down

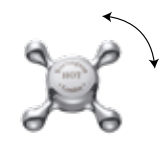

Quarter turn

**Valve options**  
All Burlington taps are available with traditional screwdown valves or with quarter-turn valves. The taps work with both low and high pressure.



## TRADITIONAL SCREW DOWN BASIN TAPS

### One tap hole



Basin mixer with high central indice with click-clack waste

Code: CL6  
Regent code: CLR6  
Black code: CL6 BLA  
Black regent code: CLR6 BLA



Basin mixer with high central indice with pop up waste

Code: CL4  
Regent code: CLR4  
Black code: CL4 BLA  
Black regent code: CLR4 BLA



Basin mixer with high central indice with plug and chain waste

Code: CL5  
Regent code: CLR5  
Black code: CL5 BLA  
Black regent code: CLR5 BLA



Bidet mixer with high central indice with plug and chain waste

Code: CL13  
Regent code: CLR13  
Black code: CL13 BLA  
Black regent code: CLR13 BLA

### Two tap hole



Basin tap 3"

Code: CL1  
Regent code: CLR1  
Black code: CL1 BLA  
Black regent code: CLR1 BLA



Basin tap 5"

Code: CL2  
Regent code: CLR2  
Black code: CL2 BLA  
Black regent code: CLR2 BLA



Two tap hole bridge mixer with swivelling spout with plug and chain waste

Code: CL10  
Regent code: CLR10  
Black code: CL10 BLA  
Black regent code: CLR10 BLA



Two tap hole arch mixer with swivelling spout with curved spout (200mm centres)

Code: CL27  
Regent code: CLR27  
Black code: CL27 BLA  
Black regent code: CLR27 BLA

## TRADITIONAL SCREW DOWN BATH TAPS

### Deck-mounted



Bath shower mixer deck-mounted with 'S' adjuster

Code: CL15  
Regent code: CLR15  
Black code: CL15 BLA  
Black regent code: CLR15 BLA



Bath filler deck-mounted

Code: CL23  
Regent code: CLR23  
Black code: CL23 BLA  
Black regent code: CLR23 BLA



Bath tap deck-mounted

Code: CL3  
Regent code: CLR3  
Black code: CL3 BLA  
Black regent code: CLR3 BLA



Angled bath shower mixer deck-mounted

Code: CL19  
Regent code: CLR19  
Black code: CL19 BLA  
Black regent code: CLR19 BLA

### Wall-mounted



Bath shower mixer wall-mounted with 'S' adjuster

Code: CL17  
Regent code: CLR17  
Black code: CL17 BLA  
Black regent code: CLR17 BLA



Angled bath shower mixer wall-mounted

Code: CL21  
Regent code: CLR21  
Black code: CL21 BLA  
Black regent code: CLR21 BLA



Bath filler wall-mounted

Code: CL24  
Regent code: CLR24  
Black code: CL24 BLA  
Black regent code: CLR24 BLA

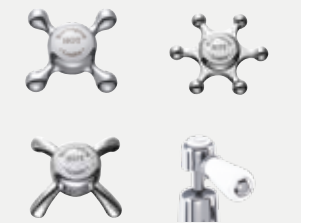

Ordering Your Taps

When ordering your taps add the correct code to the start of the tap code.

Claremont add CL  
Anglesey add AN  
Birkenhead add BI  
Kensington add KE

### Three tap hole



Two tap hole arch mixer with curved spout (230mm centre)

Code: CL28  
Regent code: CLR28  
Black code: CL28 BLA  
Black regent code: CLR28 BLA



Three tap hole mixer with pop up waste

Code: CL12  
Regent code: CLR12  
Black code: CL12 BLA  
Black regent code: CLR12 BLA

### REGENT OPTIONS

Our regent base which can be used on all one, two and three tap hole taps (excluding Chelsea and Stafford) offers an extra height of 30mm than the standard tap base and adds a further 30mm distance away from the wall when wall-mounted.



Standard



Regent

### QUARTER TURN OPTIONS

To order your tap with quarter-turn valves add QT to the end of your brassware code. (Kensington taps are only available as quarter-turn valves).



Traditional screw-down



Quarter turn



## WALNUT BASIN TAPS

### One tap hole



Basin mixer with high central indice with click-clack waste

Code: KE6 WAL QT  
Regent code: KER6 WAL QT



Basin mixer with high central indice with pop up waste

Code: KE4 WAL QT  
Regent code: KER4 WAL QT



Basin mixer with high central indice with plug and chain waste

Code: KE5 WAL QT  
Regent code: KER5 WAL QT



Bidet mixer with high central indice with plug and chain waste

Code: KE13 WAL QT  
Regent code: KER13 WAL QT

### Two tap hole



Basin tap 3"

Code: KE1 WAL QT  
Regent code: KER1 WAL QT



Basin tap 5"

Code: KE2 WAL QT  
Regent code: KER2 WAL QT



Two tap hole bridge mixer with swivelling spout with plug and chain waste

Code: KE10 WAL QT  
Regent code: KER10 WAL QT



Two tap hole arch mixer with curved spout (200mm centres)

Code: KE27 WAL QT  
Regent code: KER27 WAL QT



Two tap hole arch mixer with curved spout (230mm centre)

Code: KE28 WAL QT  
Regent code: KER28 WAL QT



Three tap hole mixer with pop up waste

Code: KE12 WAL QT  
Regent code: KER12 WAL QT



## WALNUT BATH TAPS

### Deck-mounted



Bath shower mixer deck-mounted with 'S' adjuster

Code: KE15 WAL QT  
Regent code: KER15 WAL QT



Bath filler deck-mounted

Code: KE23 WAL QT  
Regent code: KER23 WAL QT



Bath tap deck-mounted

Code: KE3 WAL QT  
Regent code: KER3 WAL QT



Angled bath shower mixer deck-mounted

Code: KE19 WAL QT  
Regent code: KER19 WAL QT

### Wall-mounted



Bath shower mixer wall-mounted with 'S' adjuster

Code: KE17 WAL QT  
Regent code: KER17 WAL QT



Angled bath shower mixer wall-mounted

Code: KE21 WAL QT  
Regent code: KER21 WAL QT



Bath filler wall-mounted

Code: KE24 WAL QT  
Regent code: KER24 WAL QT



### WALNUT OPTION

Our NEW Walnut taps give the perfect finishing touches and work beautifully with our other feature options such as WC seats and accessories.

Please note our Walnut taps are only available as Kensington with quarter-turn valves.



## THERMOSTATIC

Match your basin, bath and shower with the convenience and safety of thermostatic controls for your bathroom.



**3 tap hole basin mixer with pop up waste**  
Code: CL29  
Black Code: CL29 BLA



**Bath shower mixer deck-mounted with 'S' adjuster**  
Code: T2DB  
Black Code: T2DB BLA  
Walnut Code: T2DB WAL



**Thermostatic two outlet twin control bath shower mixer valve**  
**White Ceramic**  
BT2DS+V16  
BT2DS+V17  
BT2DS+V60  
BT2WS+V16  
BT2WS+V17  
BT2WS+V60  
**Black Ceramic**  
BT2DS BLA+V16  
BT2DS BLA+V17  
BT2DS BLA+V60  
BT2WS BLA+V16  
BT2WS BLA+V17  
BT2WS BLA+V60

### THERMOSTATIC SAFETY

We use Vernet wax capsules throughout our thermostatic brassware and showering valves, meaning temperature when in use will not vary by more than + 1 degrees.

## STAFFORD

Please note the stafford collection cannot be paired with any other tap head options.



**Stafford bath pillar taps**  
Code: STA13



**Stafford long nose basin pillar taps**  
Code: STA12



**Stafford mono basin mixer with pop up waste**  
Code: STA11



**Stafford bath shower mixer deck-mounted**  
Code: STA14  
Please note that the Stafford does not include an 'S' adjuster.

## CHELSEA



**Chelsea straight basin mixer with pop up waste**  
Code: CH20  
Black Code: CH20 BLA  
Walnut Code: CH20 WAL



**Chelsea curved basin mixer without waste**  
Code: CH21  
Black Code: CH21 BLA  
Walnut Code: CH21 WAL



**Chelsea curved basin mixer with pop up waste**  
Code: CH22  
Black Code: CH22 BLA  
Walnut Code: CH22 WAL



**Chelsea curved bidet mixer with pop up waste**  
Code: CH23  
Black Code: CH23 BLA  
Walnut Code: CH23 WAL



**Chelsea straight basin mixer without waste**  
Code: CH19  
Black Code: CH19 BLA  
Walnut Code: CH19 WAL

### UNIQUE AESTHETICS

The Chelsea brassware range comes with its own unique, bespoke tap heads and are not available as Claremont, Anglesey or Birkenhead. The lever can be changed from white to black or walnut. Chelsea's range also comes with the choice of curved or straight spout.



**Chelsea curved tall basin mixer without waste**  
Code: CHE2  
Black Code: CHE2 BLA  
Walnut Code: CHE2 WAL



**Chelsea straight tall basin mixer without waste**  
Code: CHE1  
Black Code: CHE1 BLA  
Walnut Code: CHE1 WAL



*FOR BATHS*



Shallow p trap  
Code: CW3



Bath overflow plug and chain  
Code: W3



Black bath overflow plug and chain  
Code: W3 BLA



P trap connection pipe  
Code: W21

*FOR BASINS*



Flat bottom bottle trap  
Code: W13



Traditional bottle trap  
Code: W14



Flip top basin waste, slotted, chrome  
Code: W18



Tap hole stopper, chrome  
Code: A49 CHR



Overflow filler for single/double-ended baths  
Single code: W15  
Double code: W2



Black overflow filler for single/double-ended baths  
Single code: W15 BLA



Click-clack bath waste (slotted) with chrome cover  
Code: CW1  
For use with internal overflow bath.



Click-clack bath waste (unslotted) with chrome cover  
Code: CW2  
For use without internal overflow bath.



Click-clack (push button) basin waste  
Code: W11



Basin plug and chain, slotted  
Code: W1



Burlington basin tap shut off valves (hot/cold)  
W: 348 D: 64 H: 112  
Code: W28



Black Burlington basin tap shut off valves (hot/cold)  
W: 348 D: 64 H: 112  
Code: W28 BLA

*FOR BIDETS*

*FOR WCS*

*FOR SHOWERS*



Special bath waste without a pre-drilled overflow hole  
Code: CW11  
With unslotted click-clack waste



Exposed bath overflow, click-clack waste  
Code: CW6



Exposed bath overflow, plug and chain  
Code: W4



Black exposed bath overflow, plug and chain  
Code: W4 BLA



Bidet trap  
Code: W27



Cistern tank on/off valve  
Code: W25



Black cistern tank on/off valve  
Code: W25 BLA



Angled connector for telephone handset, chrome  
Code: V62



# ARCADE BRASSWARE

Arcade

Brassware



**Nickel dual lever basin mixer without pop up waste**

W: 200 D: 184 H: 215

Code: ARC14 NKL  
Nickel Lever: ARC67 NKL  
White Lever: ARC65 NKL  
Black lever: ARC66 NKL



**Nickel single lever basin mixer without pop up waste**

W: 65 D: 174 H: 174

Code: ARC12 NKL  
Nickel Lever: ARC67 NKL  
White Lever: ARC65 NKL  
Black lever: ARC66 NKL



**Nickel mini single lever basin mixer without pop up waste**

W: 59 D: 137 H: 107

Code: ARC35 NKL  
Nickel Lever: ARC67 NKL  
White Lever: ARC65 NKL  
Black lever: ARC66 NKL

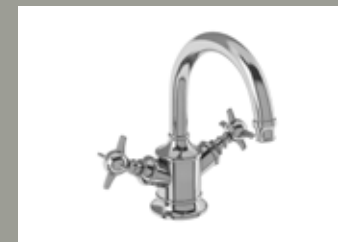

**Chrome dual lever basin mixer without pop up waste**

W: 200 D: 184 H: 215

Code: ARC14 CHR  
Chrome Lever: ARC67 CHR  
White Lever: ARC65 CHR  
Black lever: ARC66 CHR



**Chrome single lever basin mixer without pop up waste**

W: 65 D: 174 H: 174

Code: ARC12 CHR  
Chrome Lever: ARC67 CHR  
White Lever: ARC65 CHR  
Black lever: ARC66 CHR



**Chrome mini single lever basin mixer without pop up waste**

W: 59 D: 137 H: 107

Code: ARC35 CHR  
Chrome Lever: ARC67 CHR  
White Lever: ARC65 CHR  
Black lever: ARC66 CHR

## LEVER OPTIONS

Every piece of Arcade brassware, whether you choose from the elegant lustre of nickel or the high shine of chrome, is available with either crosshead tap heads or levers in corresponding nickel or chrome, serene White ceramic or intense Black ceramic, each with a timeless quality.



Crosshead



Lever



White Ceramic Lever



Matt Black Ceramic Lever



**Nickel three hole basin mixer deck-mounted without pop up waste**  
 W: 260 D: 219 H: 158  
 Code: ARC15 NKL  
 Nickel lever: ARC67 NKL  
 White lever: ARC65 NKL  
 Black lever: ARC66 NKL



**Nickel three hole basin mixer wall-mounted without pop up waste**  
 W: 260 D: 259 H: 158  
 Code: ARC16 NKL  
 Nickel lever: ARC67 NKL  
 White lever: ARC65 NKL  
 Black lever: ARC66 NKL



**Nickel basin pillar taps**  
 W: 239 D: 161 H: 150  
 Code: ARC17 NKL  
 Nickel lever: ARC67 NKL  
 White lever: ARC65 NKL  
 Black lever: ARC66 NKL



**Nickel cloakroom basin pillar taps**  
 W: 239 D: 132 H: 140  
 Code: ARC36 NKL  
 Nickel lever: ARC67 NKL  
 White lever: ARC65 NKL  
 Black lever: ARC66 NKL



**Nickel single lever bidet mixer with pop up waste**  
 W: 65 D: 192 H: 174  
 Code: ARC13 NKL  
 Nickel lever: ARC67 NKL  
 White lever: ARC65 NKL  
 Black lever: ARC66 NKL



**Nickel bath shower mixer wall-mounted**  
 W: 290 D: 280 H: 327  
 Code: ARC19 NKL  
 Nickel lever: ARC67 NKL  
 White lever: ARC65 NKL  
 Black lever: ARC66 NKL

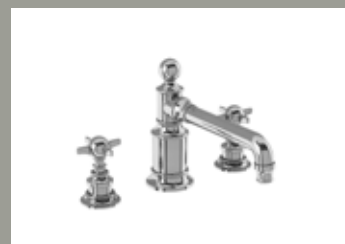

**Chrome three hole basin mixer deck-mounted without pop up waste**  
 W: 260 D: 219 H: 158  
 Code: ARC15 CHR  
 Chrome lever: ARC67 CHR  
 White lever: ARC65 CHR  
 Black lever: ARC66 CHR



**Chrome three hole basin mixer wall-mounted without pop up waste**  
 W: 260 D: 259 H: 158  
 Code: ARC16 CHR  
 Chrome lever: ARC67 CHR  
 White lever: ARC65 CHR  
 Black lever: ARC66 CHR

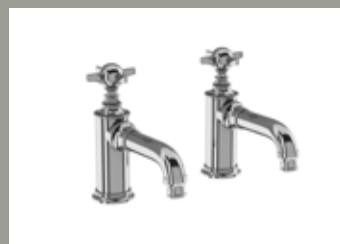

**Chrome basin pillar taps**  
 W: 239 D: 161 H: 150  
 Code: ARC17 CHR  
 Chrome lever: ARC67 CHR  
 White lever: ARC65 CHR  
 Black lever: ARC66 CHR



**Chrome cloakroom basin pillar taps**  
 W: 239 D: 132 H: 140  
 Code: ARC36 CHR  
 Chrome lever: ARC67 CHR  
 White lever: ARC65 CHR  
 Black lever: ARC66 CHR

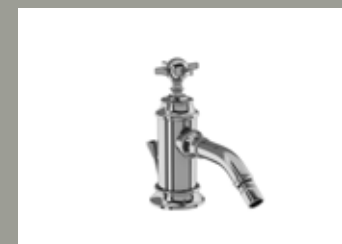

**Chrome single lever bidet mixer with pop up waste**  
 W: 65 D: 192 H: 174  
 Code: ARC13 CHR  
 Chrome lever: ARC67 CHR  
 White lever: ARC65 CHR  
 Black lever: ARC66 CHR



**Chrome bath shower mixer wall-mounted**  
 W: 290 D: 280 H: 327  
 Code: ARC19  
 Chrome lever: ARC67 CHR  
 White lever: ARC65 CHR  
 Black lever: ARC66 CHR

**FLOW RATES**

All Arcade taps are supplied with aerator's and flow straightener's. Flow rates are between 0.2 & 5 bar.



**Flow straightener**  
 This is for use with low water pressure.



**Aerator**  
 This is for use with high pressure.

**LEVER OPTIONS**

Every piece of Arcade brassware, whether you choose from the elegant lustre of nickel or the high shine of chrome, is available with either crosshead tap heads or levers in corresponding nickel or chrome, serene White ceramic or intense Black ceramic, each with a timeless quality.



**Crosshead**



**Lever**



**White Ceramic Lever**



**Matt Black Ceramic Lever**





**Nickel bath shower mixer deck-mounted**  
**W: 290 D: 370 H: 400**  
**Code: ARC18 NKL**  
**Nickel lever: ARC67 NKL**  
**White lever: ARC65 NKL**  
**Black lever: ARC66 NKL**



**Chrome bath shower mixer deck-mounted**  
**W: 290 D: 370 H: 400**  
**Code: ARC18 CHR**  
**Chrome lever: ARC67 CHR**  
**White lever: ARC65 CHR**  
**Black lever: ARC66 CHR**



**Nickel single lever bath shower filler, floor-mounted inc. floor mounting kit**  
**W: 120 D: 373 H: 825-907**  
**Code: ARC20 NKL**  
 Matt black ceramic tap lever now available for this bath filler, order separately ARC69 NKL



**Chrome single lever bath shower filler, floor-mounted inc. floor mounting kit**  
**W: 120 D: 373 H: 825-907**  
**Code: ARC20 CHR**  
 Matt black ceramic tap lever now available for this bath filler, order separately ARC69 CHR

**LEVER OPTIONS**

Every piece of Arcade brassware, whether you choose from the elegant lustre of nickel or the high shine of chrome, is available with either crosshead tap heads or levers in corresponding nickel or chrome, serene White ceramic or intense Black ceramic, each with a timeless quality.



**Crosshead**



**Lever**

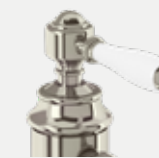

**White Ceramic Lever**



**Matt Black Ceramic Lever**

# *SHOWERING*

The Burlington range of showers provides extensive options for you to create a showering solution for your own bespoke setting. Whether you prefer showering over a bath or within an enclosure, our range of thermostatic valves offer safe and controllable showering for the entire family. Digital showering with Classic 1910 styling provide the ultimate showering experience with visual temperature control and the option of remote control. Partner either with a wide range of enclosure styles from hinged or sliding doors to quadrant enclosures, each with corresponding trays with superior strength, the best grade in non-slip technology and an anti-bacterial coating as standard.

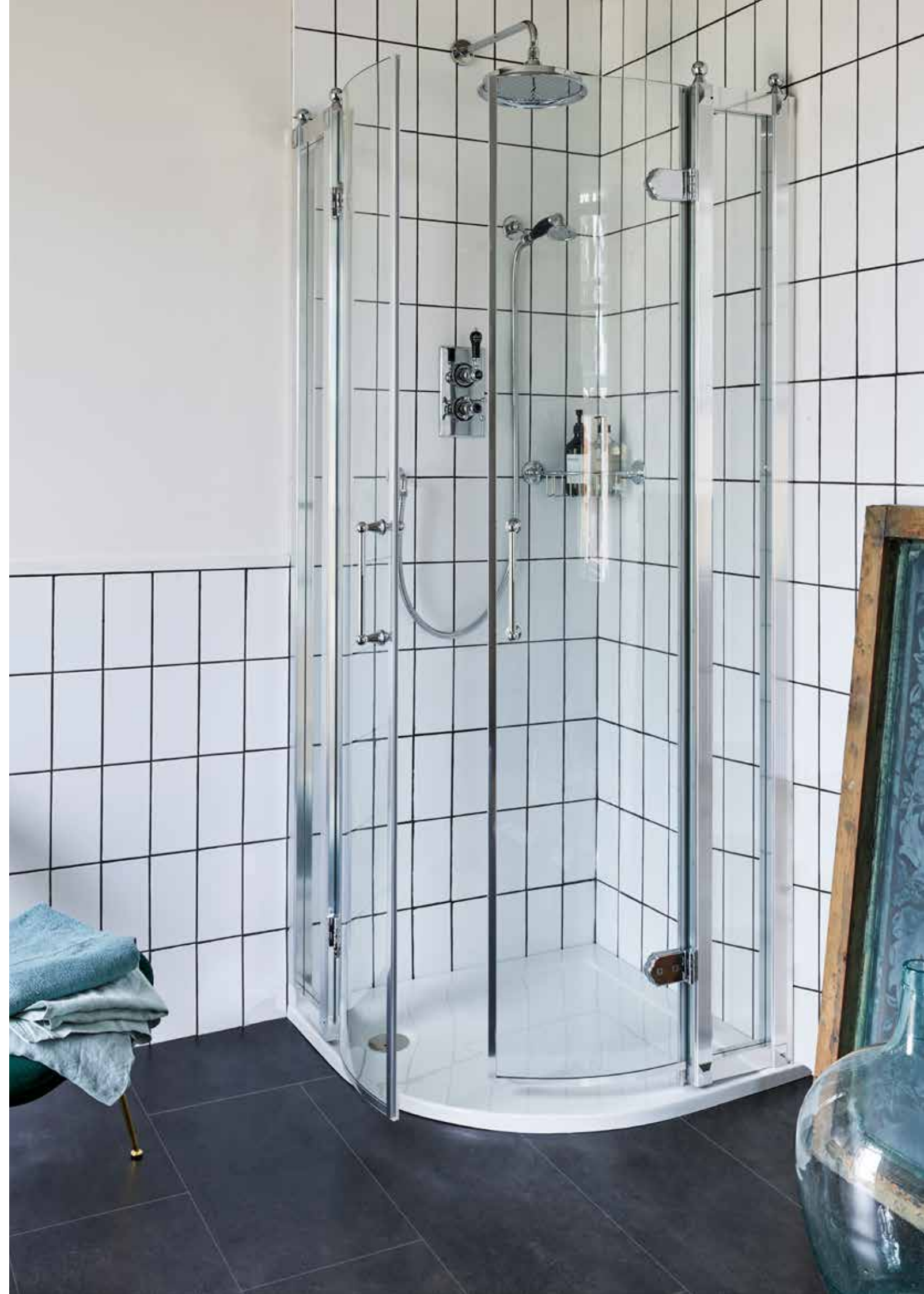



# TRENT

Concealed thermostatic showers

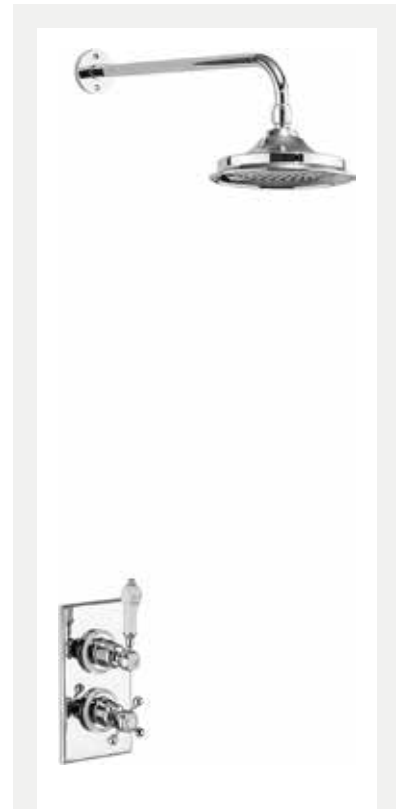

Thermostatic single function brass valve with independent temperature control

Traditional brass faceplate and Claremont handle with ceramic lever

390mm adjustable fixed shower arm

6", 9", 12" Airburst shower head

**White Ceramic**

TF1S+V16  
TF1S+V17  
TF1S+V60

**Black Ceramic**

TF1S BLA+V16  
TF1S BLA+V17  
TF1S BLA+V60



Thermostatic single function brass valve with independent temperature control

Traditional brass faceplate and Claremont handle with ceramic lever

Slide rail including the elbow, hose and handset with ceramic handle

6", 9", 12" Airburst shower head

**White Ceramic**

TF1H

**Black Ceramic**

TF1H BLA

## OPTIONAL EXTRAS

When ordering the optional bath Spout V32 you will also need the extended riser V22, if you wish to retain the handset function you will need to order V24 and V27 products.



**Soap basket**  
Code: V23



**Cradle**  
Code: V24



**Slide rail**  
Code: V33  
Black code: V33 BLA



**Ceramic handset, hose & diverter**  
Code: V27



**Spout fitting**  
Code: V32



**Extended vertical riser rail**  
Code: V22

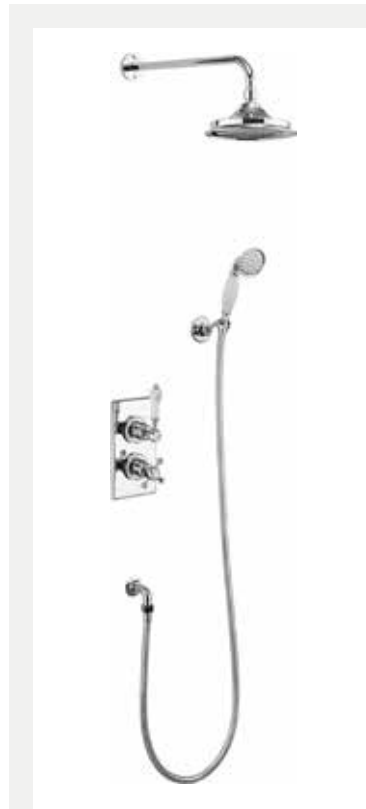

Thermostatic dual function brass valve with independent flow diverter and temperature control

Traditional brass faceplate and Claremont handle with ceramic lever

Wall outlet and 1500mm shower hose

Adjustable wall bracket and handset with ceramic handle

390mm adjustable shower arm

6", 9", 12" Airburst shower head

**White Ceramic**

TF2S+V16  
TF2S+V17  
TF2S+V60

**Black Ceramic**

TF2S BLA+V16  
TF2S BLA+V17  
TF2S BLA+V60

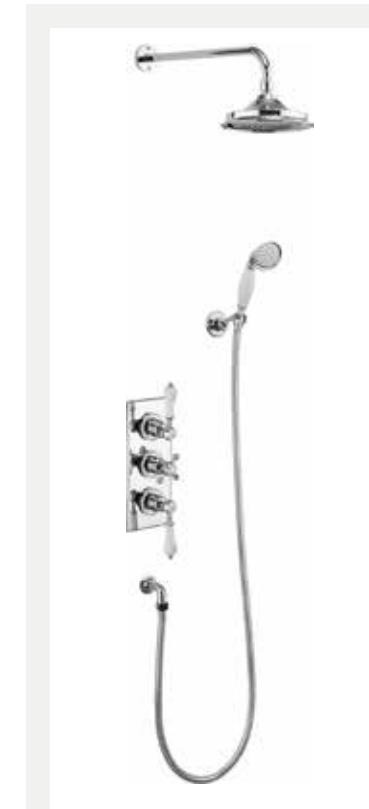

Thermostatic dual function brass valve with two independent on/ off controls and central temperature control

Traditional brass faceplate and Claremont handle with ceramic lever

Wall outlet and 1500mm shower hose

Adjustable wall bracket and handset with ceramic handle

390mm adjustable shower arm

6", 9", 12" Airburst shower head

**White Ceramic**

TF3S+V16  
TF3S+V17  
TF3S+V60

**Black Ceramic**

TF3S BLA+V16  
TF3S BLA+V17  
TF3S BLA+V60

## THERMOSTATIC SHOWERING

Within the valve there is an automatic adjuster which maintains temperature by adjusting the flow of each supply. This is useful in guarding against the possibility of scalding. If for instance, someone flushes a WC whilst you are showering, the flow of hot water will immediately be closed down to compensate for the reduced cold water flow.

## SHOWER VALVE HANDLE OPTIONS



**Anglesey single valve**

White code: V2  
Black code: V2 BLA

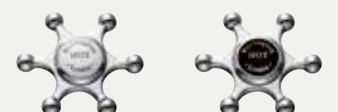

**Birkenhead single valve**

White code: V3  
Black code: V3 BLA

# SEVERN

Concealed thermostatic showers

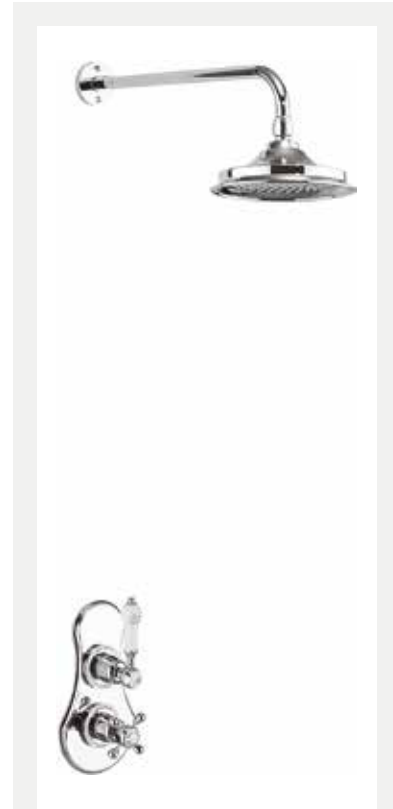

Thermostatic single function brass valve with independent temperature control

Traditional brass faceplate and Claremont handle with ceramic lever

390mm adjustable fixed shower arm

6", 9", 12" AirBurst shower head

White Ceramic

VF1S+V16  
VF1S+V17  
VF1S+V60

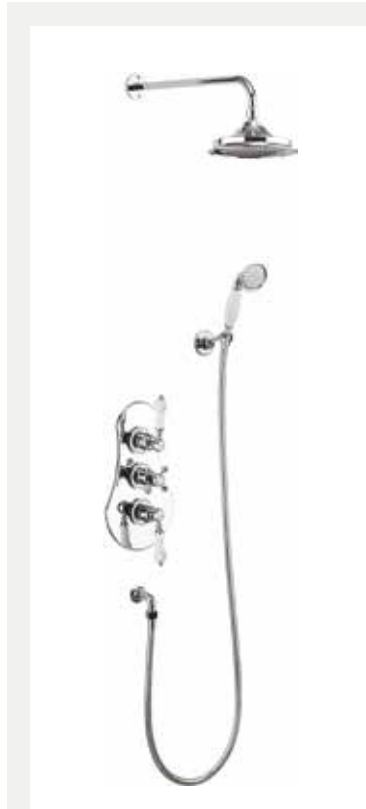

Thermostatic dual function brass valve with two independent on / off controls and central temperature control

Traditional brass faceplate and Claremont handle with ceramic lever

Wall outlet and 1500mm shower hose

Adjustable wall bracket and handset with ceramic handle

390mm adjustable shower arm  
6", 9", 12" AirBurst shower head

White Ceramic

VF3S+V16  
VF3S+V17  
VF3S+V60

### OPTIONAL EXTRAS

When ordering the optional bath spout V32 you will also need the extended riser V22, if you wish to retain the handset function you will need to order V24 and V27 products.



Soap basket  
Code: V23



Cradle  
Code: V24



Slide rail  
Code: V33  
Black code: V33 BLA



Ceramic handset, hose & diverter  
Code: V27



Spout fitting  
Code: V32



Extended vertical riser rail  
Code: V22

# AVON

Exposed thermostatic showers

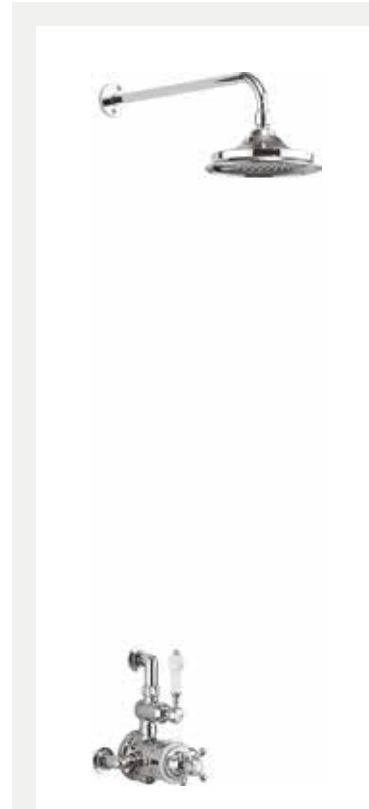

Thermostatic single function brass valve with independent temperature control

Traditional brass body and Claremont handle with ceramic lever

390mm adjustable fixed shower arm

6", 9", 12" AirBurst shower head

White Ceramic

AF1S+V16  
AF1S+V17  
AF1S+V60

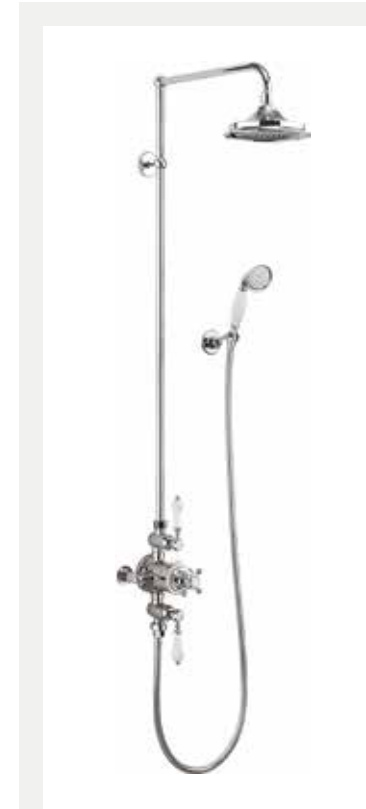

Thermostatic dual function brass valve with two independent on / off controls and central temperature control

Traditional brass body and Claremont handle with ceramic lever

Adjustable wall bracket, 1500mm shower hose and handset with ceramic handle

18mm diameter vertical brass shower riser

355mm adjustable swivel shower arm

6", 9", 12" AirBurst shower head

White Ceramic

BAF3S+V16  
BAF3S+V17  
BAF3S+V60  
BAF3S.EXT+V16  
BAF3S.EXT+V17  
BAF3S.EXT+V60

Black Ceramic

BAF3S BLA+V16  
BAF3S BLA+V17  
BAF3S BLA+V60  
BAF3S.EXT BLA+V16  
BAF3S.EXT BLA+V17  
BAF3S.EXT BLA+V60

### SHOWER HEAD HEIGHT



The standard riser pipe (V21) has a length of 856mm.

To increase the height of your shower head use the extended riser (V22) which has a length of 1814mm increasing the height by 958mm.

To order the extended riser simply add .EXT to the product code. For example BSF1S changes to BSF1S.EXT

Please see the [burlingtonbathrooms.com](http://burlingtonbathrooms.com) for details.

### SHOWER VALVE HANDLE OPTIONS



Anglesey single valve

White code: V2  
Black code: V2 BLA

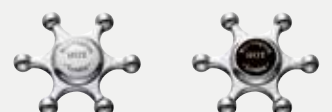

Birkenhead single valve

White code: V3  
Black code: V3 BLA



# TAY

## Bath shower thermostatic showers



Thermostatic two outlet twin control bath shower mixer valve with independent flow diverter and temperature controls

Traditional brass body and Claremont handles, with ceramic indices

Brass bath spout with swivel function

Available deck or wall-mounted

S connector and bracket, 1500mm shower hose and handset with ceramic handle

White Ceramic  
Deck: T2DB  
Wall: T2WB

Black Ceramic  
Deck: T2DB BLA  
Wall: T2WB BLA



Thermostatic two outlet twin control bath shower mixer valve with independent flow diverter and temperature controls

Traditional brass body and Claremont handles, with ceramic indices

Brass bath spout with swivel function

Available deck or wall-mounted

18mm diameter vertical brass shower riser

355mm adjustable swivel shower arm

6", 9", 12" AirBurst shower head

White Ceramic  
Deck: BT2DS+V16  
Deck: BT2DS+V17  
Deck: BT2DS+V60  
Wall: BT2WS+V16  
Wall: BT2WS+V17  
Wall: BT2WS+V60

Black Ceramic  
Deck: BT2DS BLA+V16  
Deck: BT2DS BLA+V17  
Deck: BT2DS BLA+V60  
Wall: BT2WS BLA+V16  
Wall: BT2WS BLA+V17  
Wall: BT2WS BLA+V60

### OPTIONAL EXTRAS

When ordering the optional bath Spout V32 you will also need the extended riser V22, if you wish to retain the handset function you will need to order V24 and V27 products.

 Soap basket  
Code: V23

 Cradle  
Code: V24

 Slide rail  
Code: V33  
Black code: V33 BLA

 Ceramic handset, hose & diverter  
Code: V27

 Spout fitting  
Code: V32

 Extended vertical riser rail  
Code: V22

# EDEN

## Exposed thermostatic showers



Thermostatic single outlet twin control valve with independent on/off flow and temperature control

Traditional brass body and Claremont handle with ceramic indices

18mm diameter vertical brass shower riser

355mm adjustable swivel shower arm

6", 9", 12" AirBurst shower head

White Ceramic  
BEF1S+V16  
BEF1S+V17  
BEF1S+V60  
BEF1S.EXT+V16  
BEF1S.EXT+V17  
BEF1S.EXT+V60

Black Ceramic  
BEF1S BLA+V16  
BEF1S BLA+V17  
BEF1S BLA+V60  
BEF1S.EXT BLA+V16  
BEF1S.EXT BLA+V17  
BEF1S.EXT BLA+V60

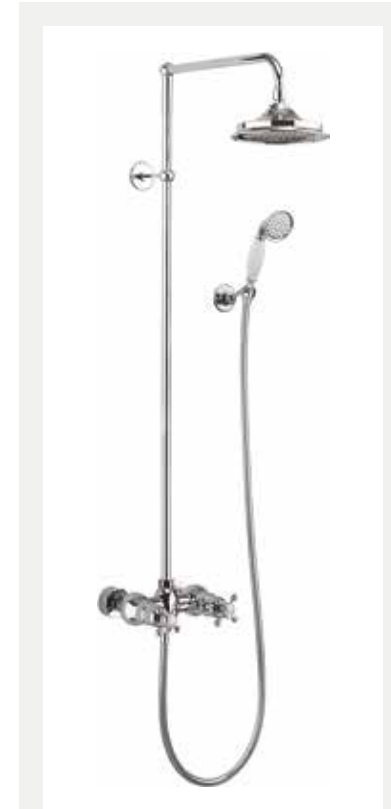

Thermostatic two outlet twin control valve with independent flow diverter and temperature control

Traditional brass body and Claremont handle with ceramic indices

Adjustable wall bracket, 1500mm shower hose and handset with ceramic handle

18mm diameter vertical brass shower riser

355mm adjustable swivel shower arm

6", 9", 12" AirBurst shower head

White Ceramic  
BEF2S+V16  
BEF2S+V17  
BEF2S+V60  
BEF2S.EXT+V16  
BEF2S.EXT+V17  
BEF2S.EXT+V60

Black Ceramic  
BEF2S BLA+V16  
BEF2S BLA+V17  
BEF2S BLA+V60  
BEF2S.EXT BLA+V16  
BEF2S.EXT BLA+V17  
BEF2S.EXT BLA+V60

### ONE WAY WATER

Our non-return valves ensure the flow of water in only one direction, ensuring heating efficiency, preventing siphonage of contaminated water and keeping your shower cartridge in excellent condition for longer.

### AIRBURST SHOWER HEADS

By combining air and water, the pressure inside the shower head is increased. The power of a traditional shower head with up to 33% water saved.

### SHOWER VALVE HANDLE OPTIONS



Anglesey single valve

White code: V2  
Black code: V2 BLA

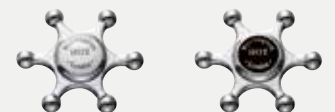

Birkenhead single valve

White code: V3  
Black code: V3 BLA

# STOUR

## Exposed thermostatic showers

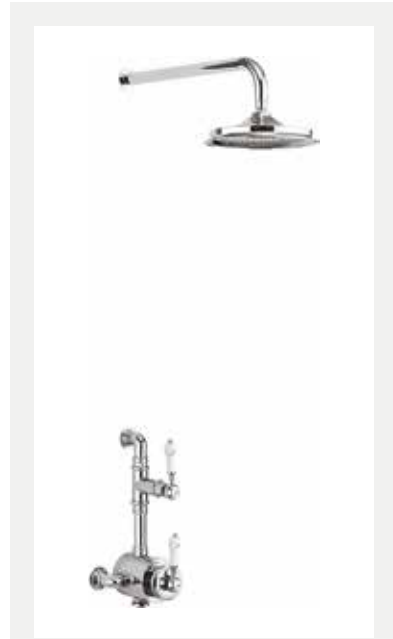

Thermostatic single function brass valve with independent temperature control

Traditional brass body and Claremont handle with ceramic lever

6", 9", 12" AirBurst shower head

White Ceramic

- BF1S+V16
- BF1S+V17
- BF1S+V60



Thermostatic single function brass valve with independent temperature control

Traditional brass body and Claremont handle with ceramic lever

28mm diameter vertical brass shower riser

450mm adjustable fixed shower arm

Soap basket

6", 9", 12" AirBurst shower head

White Ceramic

- BF2S+V16
- BF2S+V17
- BF2S+V60

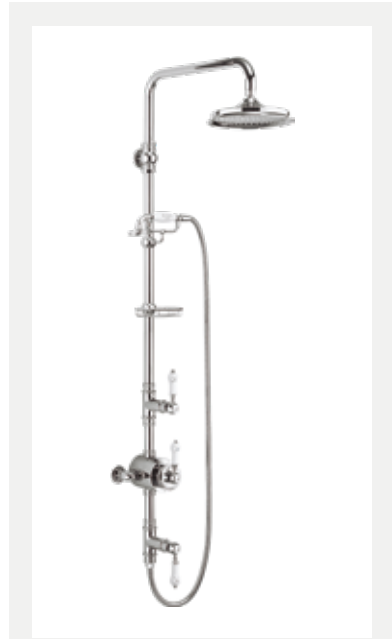

Thermostatic dual function brass valve with two independent on / off controls and central temperature control

Traditional brass body, Claremont handle with ceramic lever

Fixed cradle, 1500mm shower hose and handset with ceramic handle

28mm diameter vertical brass shower riser

450mm adjustable fixed shower arm

Soap basket

6", 9", 12" AirBurst shower head

White Ceramic

- BF3S+V16
- BF3S+V17
- BF3S+V60

### NEW BLACK OPTION

New Black lever and handle options are now available for all Eden, Tay, Trent shower valves and Avon dual function valves.





# CLASSIC 1910

Create the ultimate showering experience with the innovative Classic 1910 digital kits. With precise temperature technology and high-quality design, the Digital shower makes safety, simplicity and sophistication integral to your everyday routine.

## Consistent temperature

A built-in thermistor checks the temperature 10 times every second so that, even when someone is using water elsewhere in the house, the water temperature will stay exactly the same.

## Automatic shut off

If there are any problems with your water supply, the shower will shut off immediately. This provides peace of mind that your family is fully protected from hot water scalding, or the discomfort of an unexpected cold shower.

## Remote control (optional)

Fit an optional remote control anywhere outside of the shower enclosure and within 10 metres of the digital shower. Simply press the button to turn the shower on or off, or press and hold for 1.5 seconds to divert the water flow between showerheads, or bath and shower.

## Cleaning mode

While the shower is off, set the temperature to midway between hot and cold, then press and hold the dial for 5 seconds. The light on the controller will come on to show you it's locked, then after one minute it will automatically unlock.

## Quiet pump

For low-pressure installations the digital shower features an ultra quiet, integrated brushless motor, boosting performance to allow high-pressure showering with minimum noise.



## Cool-touch metal controls

Shower controls are kept completely separate from the water in the valve, which means they always stay cool and safe to touch.

## Precise temperature

Sophisticated technology gives you accurate control of the water temperature.

## Temperature override

Each digital processor has a pre-set maximum temperature of 41°C, which can be overridden and adjusted to 46°C. As bath temperatures are usually higher, when you divert to the bath outlet the maximum temperature will automatically rise to 44°C.

## Colour-changing controls

The controls gently pulse white as the water reaches your set temperature, while a subtle, white glow lets you know the shower's ready. When you adjust the temperature the controls flash red or blue as the water heats up or cools down.

## Easy divert

Divert the flow quickly and easily with just a few touches. Press the lower control once to divert from the main showerhead to the second, and again to run both at once. On the dual bath and shower, press once to switch to showerhead, and a second time to return to bath flow.



## CLASSIC 1910 DIGITAL KIT OPTIONS

Our selection of product options enables you to create a showering experience individual to you and your home. Choose between single and dual shower and bath fill controls then combine with stunning fixtures to achieve your ideal look. Introduce a final touch of elegance with the digital remote, a unique additional control that allows you to smoothly turn on the water and divert the flow before you even enter the shower.



**Dual outlet (shower)**  
W: 112 H: 208  
High pressure: TK12  
Low pressure: TK13



**Dual outlet (bath / shower)**  
W: 112 H: 208  
High pressure: TK14  
Low pressure: TK15



**Single outlet**  
W: 95 H: 95  
High pressure: TK10  
Low pressure: TK11



**Remote control (optional)**  
W: 95 H: 95  
Code: TK5

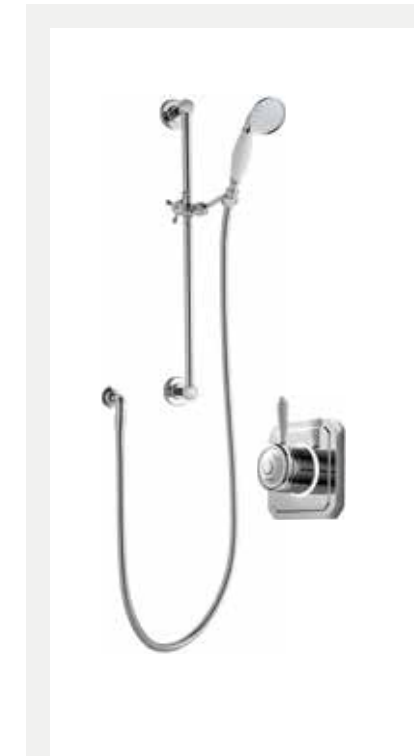

### CLASSIC 1910 SINGLE OUTLET SET

Single outlet digital processor  
Traditional trim kit  
Traditional slide bar kit

High pressure: TK2  
Low pressure: TK7  
Remote control: TK5



**Soap basket**  
Code: V23  
Can be used with dual outlet set



**Cradle**  
Code: V24  
Can be used with dual outlet set



### CLASSIC 1910 SINGLE OUTLET SET

Single outlet digital processor  
Traditional trim kit  
Wall arm  
9" AirBurst shower head

High pressure: TK1M  
Low pressure: TK6M  
Remote control: TK5

**6" Airburst shower head**  
Wall arm  
High pressure code: TK1S  
Low pressure code: TK6S

**12" Airburst shower head**  
Wall arm  
High pressure code: TK1L  
Low pressure code: TK6L

**Ceiling arm**  
High pressure code: TK1CS  
Low pressure code: TK6CS

**Ceiling arm**  
High pressure code: TK1CL  
Low pressure code: TK6CL

**9" Airburst shower head**  
Ceiling arm  
High pressure code: TK1CM  
Low pressure code: TK6CM

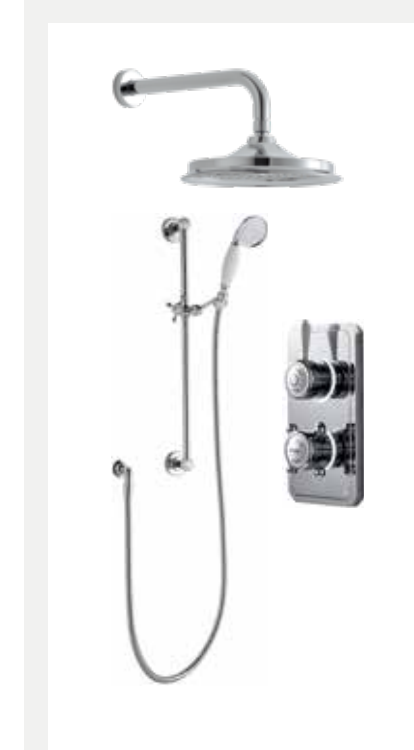

### CLASSIC 1910 DUAL OUTLET SET

Dual outlet digital processor  
Traditional trim kit  
Wall arm  
9" AirBurst shower head  
Traditional slide bar kit

High pressure: TK3M  
Low pressure: TK8M  
Remote control: TK5

**6" Airburst shower head**  
Wall arm  
High pressure code: TK3S  
Low pressure code: TK8S

**12" Airburst shower head**  
Wall arm  
High pressure code: TK3L  
Low pressure code: TK8L

**Ceiling arm**  
High pressure code: TK3CS  
Low pressure code: TK8CS

**Ceiling arm**  
High pressure code: TK3CL  
Low pressure code: TK8CL

**9" Airburst shower head**  
Ceiling arm  
High pressure code: TK3CM  
Low pressure code: TK8CM





# SHOWER SETS

**CLASSIC 1910 DUAL OUTLET SET**



Dual outlet digital processor  
Traditional trim kit  
Wall arm  
9" AirBurst shower head  
Traditional slide bar kit  
Soap basket for slide bar

**High pressure:** TK3M  
**Low pressure:** TK8M  
**Remote control:** TK5

**6" Airburst shower head**  
Wall arm  
High pressure code: TK3SB  
Low pressure code: TK8SB

**12" Airburst shower head**  
Wall arm  
High pressure code: TK3LB  
Low pressure code: TK8LB

**Ceiling arm**  
High pressure code: TK3CSB  
Low pressure code: TK8CSB

**9" Airburst shower head**  
Ceiling arm  
High pressure code: TK3CMB  
Low pressure code: TK8CMB



**CLASSIC 1910 DUAL OUTLET SET**



Dual outlet digital processor  
Traditional trim kit  
Wall arm  
9" AirBurst shower head  
Overflow bath filler with pop-up waste

**High pressure:** TK4M  
**Low pressure:** TK9M  
**Remote control:** TK5

**6" Airburst shower head**  
Wall arm  
High pressure code: TK4S  
Low pressure code: TK9S

**12" Airburst shower head**  
Wall arm  
High pressure code: TK4L  
Low pressure code: TK9L

**Ceiling arm**  
High pressure code: TK4CS  
Low pressure code: TK9CS

**9" Airburst shower head**  
Ceiling arm  
High pressure code: TK4CM  
Low pressure code: TK9CM



**CLASSIC 1910 DUAL OUTLET SET**



Dual outlet digital processor  
Traditional trim kit  
Wall arm  
9" AirBurst shower head  
Handspray kit (including shower hook, telephone handset & hose 1/2" outlet elbow)

**High pressure:** TK3MH  
**Low pressure:** TK8MH  
**Remote control:** TK5

**6" Airburst shower head**  
Wall arm  
High pressure code: TK3SH  
Low pressure code: TK8SH

**12" Airburst shower head**  
Wall arm  
High pressure code: TK3LH  
Low pressure code: TK8LH

**Ceiling arm**  
High pressure code: TK3CSH  
Low pressure code: TK8CSH

**9" Airburst shower head**  
Ceiling arm  
High pressure code: TK3CMH  
Low pressure code: TK8CMH



**CLASSIC 1910 BATH SHOWER SET**

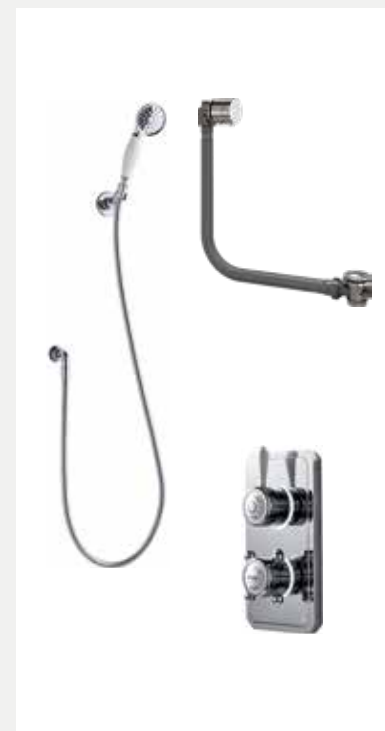

Dual outlet digital processor  
Traditional trim kit  
Overflow bath filler with pop-up waste  
Handspray kit (including shower hook, telephone handset & hose 1/2" outlet elbow)

**High pressure:** TK4H  
**Low pressure:** TK9H  
**Remote control:** TK5

**Remote control (optional)**  
W: 95 H: 95  
Code: TK5

# ARCADE SHOWER VALVES



## SHOWER VALVES



Shower valve, shower arm  
and shower head packs

Nickel with 9" shower head  
ARC73 + ARCV17 NKL

Nickel with 12" shower head  
ARC73 + ARCV60 NKL



Shower valve, shower arm,  
shower head, rail, handset  
and hose packs

Nickel with 9" shower head  
ARC64 + ARCV17 NKL

Nickel with 12" shower head  
ARC64 + ARCV60 NKL



Arcade Avon exposed  
thermostatic shower valve,  
standard vertical riser, straight  
shower arm for vertical riser  
mounting, 9 inch shower rose,  
soap basket for vertical riser,  
telephone handset & hose packs

Nickel with 9" shower head  
ARC74 + ARCV17 NKL

Nickel with 12" shower head  
ARC74 + ARCV60 NKL

Matt black ceramic levers are now available for arcade shower valves,  
order separately ARC68

### ANTI LIMESCALE

Our shower heads are not only powerful with air burst technology but also are manufactured from quality materials, minimising potential limescale effects and enabling extended lifetimes.



## SHOWER VALVES



Shower valve, shower arm and shower head packs

Chrome with 9" shower head  
ARC73 CHR + ARCV17 CHR

Chrome with 12" shower head  
ARC73 CHR + ARCV60 CHR



Shower valve, shower arm, shower head, rail, handset and hose packs

Chrome with 9" shower head  
ARC64 CHR + ARCV17 CHR

Chrome with 12" shower head  
ARC64 CHR + ARCV60 CHR



Arcade Avon exposed thermostatic shower valve, standard vertical riser, straight shower arm for vertical riser mounting, 9 inch shower rose, soap basket for vertical riser, telephone handset & hose packs

Chrome with 9" shower head  
BARC74 CHR + ARCV17 CHR

Chrome with 12" shower head  
BARC74 CHR + ARCV60 CHR

## OPTIONAL EXTRAS



Spout

Nickel: ARCV32 NKL  
Chrome: ARCV32 CHR



Diverter for handset

Nickel: ARCV31 NKL



Adjustable shower handset bracket

Chrome: ARCV34 CHR  
Nickel: ARCV34 NKL



Soap basket for vertical riser

Nickel: ARCV23 NKL  
Chrome: ARCV23 CHR

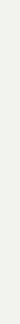

Long riser rail

Nickel: ARCV22 NKL  
Chrome: ARCV22 CHR

Matt black ceramic levers are now available for arcade shower valves, order separately ARC68

### CERAMIC DISC TECHNOLOGY

All Burlington shower valves offer ceramic disc technology so just one quarter turn and the shower will turn off straight away, preventing the frustrating dripping sound expected from usual traditional styled shower valves.



## HINGED DOORS

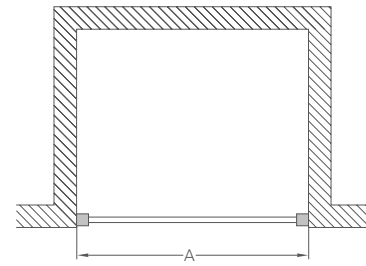

Size*	Adjustment min-max	Enclosure code	Tray code
760 x 760	720 - 760	BU1 (C19)	Z1159
800 x 800	760 - 800	BU2 (C20)	Z1160
900 x 760	860 - 900	BU3 (C21)	Z1163
900 x 800	860 - 900	BU3 (C21)	Z1164
900 x 900	860 - 900	BU3 (C21)	Z1161
900 x 1200	860 - 900	BU3 (C21)	Z1176

\*This indicates depth of matching tray size available for use in a recessed installation. All enclosures are 1950mm high and adjustable up to 20mm from each wall.

All shower posts are constructed from aluminium and can be installed with or without chrome ball header. Safety glass is 8mm thick and 3M™ easy clean coating.

Shower tray prices exclude waste  
Code: Z1205

## HINGED DOORS & SIDE PANELS

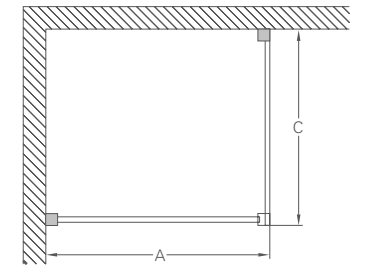

Size*	Adjustment min-max	Enclosure code	Tray code
760 x 760	730 - 750	BU11 (C19 + C12)	Z1159
760 x 900	730 - 750 870 - 890	BU12 (C19 + C14)	Z1163
800 x 800	770 - 790	BU13 (C20 + C13)	Z1160
800 x 900	770 - 790 870 - 890	BU14 (C20 + C14)	Z1164
900 x 760	730 - 750 870 - 890	BU15 (C21 + C12)	Z1163
900 x 800	770 - 790 870 - 890	BU16 (C21 + C13)	Z1164
900 x 900	870 - 900	BU17 (C21 + C14)	Z1161

\*This indicates depth of matching tray size available for use in a recessed installation. All enclosures are 1950mm high and adjustable up to 20mm from each wall.

All shower posts are constructed from aluminium and can be installed with or without chrome ball header. Safety glass is 8mm thick and 3M™ easy clean coating.

Shower tray prices exclude waste  
Code: Z1205



## HINGED DOORS & SIDE PANELS

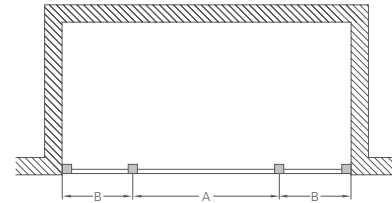

## HINGED DOORS & SIDE PANELS

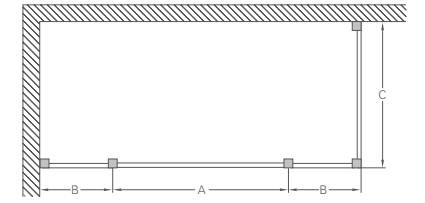

Size*	Adjustment min-max	Enclosure code	Tray code
1000 x 700	960 - 1000	BU4 (C20 + C15)	Z1165
1000 x 760	960 - 1000	BU4 (C20 + C15)	Z1166
1000 x 800	960 - 1000	BU4 (C20 + C15)	Z1167
1000 x 900	960 - 1000	BU4 (C20 + C15)	Z1168
1000 x 1000	960 - 1000	BU4 (C20 + C15)	Z1162
1100 x 700	1060 - 1100	BU5 (C20 + C16)	Z1169
1100 x 760	1060 - 1100	BU5 (C20 + C16)	Z1170
1100 x 800	1060 - 1100	BU5 (C20 + C16)	Z1171
1100 x 900	1060 - 1100	BU5 (C20 + C16)	Z1172
1200 x 700	1160 - 1200	BU6 (C20 + C17)	Z1173
1200x 760	1160 - 1200	BU6 (C20 + C17)	Z1174
1200 x 800	1160 - 1200	BU6 (C20 + C17)	Z1175
1200 x 900	1160 - 1200	BU6 (C20 + C17)	Z1176
1400 x 800	1360 - 1400	BU7 (C20 + C16 + C16)	Z1177
1400 x 900	1360 - 1400	BU7 (C20 + C16 + C16)	Z1178
1500 x 700	1460 - 1500	BU8 (C21 + C16 + C16)	Z1179
1500 x 760	1460 - 1500	BU8 (C21 + C16 + C16)	Z1180
1500 x 800	1460 - 1500	BU8 (C21 + C16 + C16)	Z1181
1600 x 700	1560 - 1600	BU9 (C20 + C16 + C16)	Z1182
1700 x 700	1560 - 1700	BU10 (C21 + C16 + C16)	Z1183
1700 x 760	1660 - 1700	BU10 (C21 + C16 + C16)	Z1184
1700 x 800	1660 - 1700	BU10 (C21 + C16 + C16)	Z1185

\*This indicates depth of matching tray size available for use in a recessed installation. All enclosures are 1950mm high and adjustable up to 20mm from each wall.

All shower posts are constructed from aluminium and can be installed with or without chrome ball header. Safety glass is 8mm thick and 3M™ easy clean coating.

Shower tray prices exclude waste  
Code: Z1205

Size*	Adjustment min-max	Enclosure code	Tray code
1000 x 760	730 - 750 970 - 990	BU19 (C20 + C15 + C12)	Z1166
1000 x 800	770 - 790 970 - 990	BU20 (C20 + C15 + C13)	Z1167
1000 x 900	870 - 890 970 - 990	BU21 (C20 + C15 + C14)	Z1168
1100 x 760	730 - 750 1070 - 1090	BU23 (C20 + C16 + C12)	Z1170
1100 x 800	770 - 790 1070 - 1090	BU24 (C20 + C16 + C13)	Z1171
1100 x 900	870 - 890 1070 - 1090	BU25 (C20 + C16 + C14)	Z1172
1200 x 760	730 - 750 1170 - 1190	BU27 (C20 + C17 + C12)	Z1174
1200 x 800	770 - 790 1170 - 1190	BU28 (C20 + C17 + C13)	Z1175
1200 x 900	870 - 890 1170 - 1190	BU29 (C20 + C17 + C14)	Z1176
1400 x 800	770 - 790 1370 - 1390	BU30 (C20 + C16 + C16 + C13)	Z1177
1400x 900	870 - 890 1370 - 1390	BU31 (C20 + C16 + C16 + C14)	Z1178
1500 x 760	730 - 750 1470 - 1490	BU33 (C21 + C16 + C16 + C12)	Z1180
1500 x 800	770 - 790 1470 - 1490	BU34 (C21 + C16 + C16 + C13)	Z1181
1700 x 760	730 - 750 1670 - 1690	BU37 (C21 + C17+ C17 + C12)	Z1184
1700 x 800	770 - 790 1670 - 1690	BU38 (C21 + C17+ C17 + C13)	Z1185

\*This indicates depth of matching tray size available for use in a recessed installation. All enclosures are 1950mm high and adjustable up to 20mm from each wall.

All shower posts are constructed from aluminium and can be installed with or without chrome ball header. Safety glass is 8mm thick and 3M™ easy clean coating.

Shower tray prices exclude waste  
Code: Z1205

## QUADRANTS

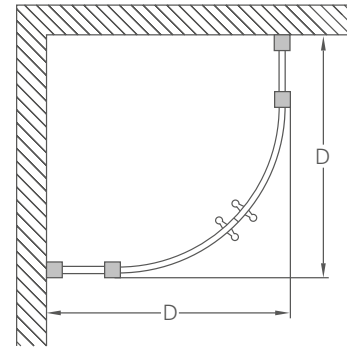

Size*	Adjustment min-max	Enclosure code	Tray code
800 x 800	770 - 790	BU39 (C22)	Z1192
900 x 900	870 - 890	BU40 (C23)	Z1193

\*This indicates depth of matching tray size available for use in a recessed installation. All enclosures are 1950mm high and adjustable up to 20mm from each wall.

All shower posts are constructed from aluminium and can be installed with or without chrome ball header. Safety glass is 8mm thick and 3M™ easy clean coating.

Shower tray prices exclude waste  
Code: Z1205

## OFFSET QUADRANTS

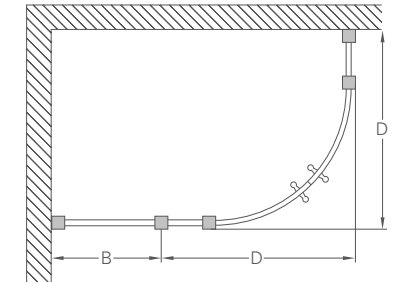

Right hand

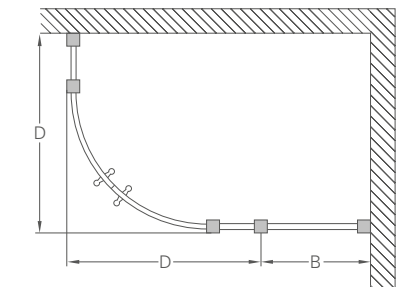

Left hand

Size*	Adjustment min-max	Enclosure code	Tray code
800 x 1000 Left hand	730 - 790 970 - 990	BU41 (C22 + C15)	Z1199
800 x 1000 Right hand	770 - 790 970 - 990	BU41 (C22 + C15)	Z1200
800 x 1200 Left hand	770 - 790 1170 - 1190	BU91 (C22 + C17)	Z1201
800 x 1200 Right hand	770 - 790 1170 - 1190	BU91 (C22 + C17)	Z1202
900 x 1200 Left hand	870 - 890 1170 - 1190	BU42 (C23 + C16)	Z1203
900 x 1200 Right hand	870 - 890 1170 - 1190	BU42 (C23 + C16)	Z1204

\*This indicates depth of matching tray size available for use in a recessed installation. All enclosures are 1950mm high and adjustable up to 20mm from each wall.

All shower posts are constructed from aluminium and can be installed with or without chrome ball header. Safety glass is 8mm thick and 3M™ easy clean coating.

Shower tray prices exclude waste  
Code: Z1205



## SLIDING DOORS

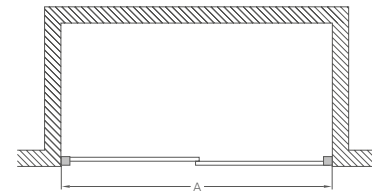

Sliding door

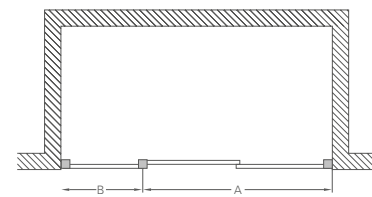

Sliding door with in line panel

### SOFT-CLOSE SLIDING DOOR

Size*	Adjustment min-max	Enclosure code	Tray code
1100 x 700	1070 - 1090	BU68 (C6S)	Z1169
1100 x 760	1070 - 1090	BU68 (C6S)	Z1170
1100 x 800	1070 - 1090	BU68 (C6S)	Z1171
1100 x 900	1070 - 1090	BU68 (C6S)	Z1172
1200 x 700	1170 - 1090	BU69 (C7S)	Z1173
1200 x 760	1170 - 1090	BU69 (C7S)	Z1174
1200 x 800	1170 - 1090	BU69 (C7S)	Z1175
1200 x 900	1170 - 1090	BU69 (C7S)	Z1176
1400 x 800	1370 - 1390	BU70 (C8S)	Z1177
1400 x 800	1370 - 1390	BU70 (C8S)	Z1178

\*This indicates depth of matching tray size available for use in a recessed installation. All enclosures are 1950mm high and adjustable up to 20mm from each wall.

All shower posts are constructed from aluminium and can be installed with or without chrome ball header. Safety glass is 8mm thick and 3M™ easy clean coating.

Shower tray prices exclude waste  
Code: Z1205

### SOFT-CLOSE SLIDING DOOR WITH IN LINE PANEL

Size*	Adjustment min-max	Enclosure code	Tray code
1000 x 760	730 - 750 970 - 990	BU19 (C20 + C15 + C12)	Z1166
1000 x 800	770 - 790 970 - 990	BU20 (C20 + C15 + C13)	Z1167
1000 x 900	870 - 890 970 - 990	BU21 (C20 + C15 + C14)	Z1168
1100 x 760	730 - 750 1070 - 1090	BU23 (C20 + C16 + C12)	Z1170
1100 x 800	770 - 790 1070 - 1090	BU24 (C20 + C16 + C13)	Z1171
1100 x 900	870 - 890 1070 - 1090	BU25 (C20 + C16 + C14)	Z1172
1100 x 900	730 - 750 1170 - 1190	BU27 (C20 + C17 + C12)	Z1174

## SLIDING DOORS WITH SIDE PANELS

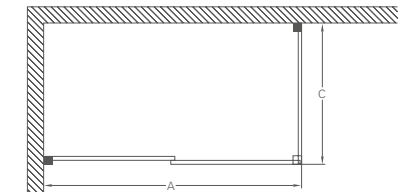

Sliding door with side panel

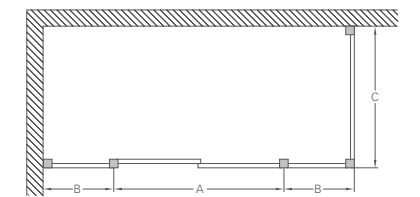

Sliding door with in line and side panel

### SOFT-CLOSE SLIDING DOOR WITH SIDE PANEL

Size*	Adjustment min-max	Enclosure code	Tray code
1100 x 760	730 - 750 1070 - 1090	BU75 (C6S + C12)	Z1170
1100 x 800	770 - 790 1070 - 1090	BU76 (C6S + C13)	Z1171
1100 x 900	870 - 890 1070 - 1090	BU77 (C6S + C14)	Z1172
1200 x 760	730 - 750 1070 - 1090	BU79 (C7S + C12)	Z1174
1200 x 800	770 - 790 1070 - 1090	BU80 (C7S + C13)	Z1175
1200 x 900	870 - 890 1070 - 1090	BU81 (C7S + C14)	Z1176
1400 x 800	770 - 790 1370 - 1390	BU82 (C8S + C13)	Z1177
1400 x 900	870 - 890 1370 - 1390	BU83 (C8S + C14)	Z1178

\*This indicates depth of matching tray size available for use in a recessed installation. All enclosures are 1950mm high and adjustable up to 20mm from each wall.

All shower posts are constructed from aluminium and can be installed with or without chrome ball header. Safety glass is 8mm thick and 3M™ easy clean coating.

Shower tray prices exclude waste  
Code: Z1205

### SOFT-CLOSE SLIDING DOOR WITH IN LINE & SIDE PANEL

Size*	Adjustment min-max	Enclosure code	Tray code
1500 x 760	730 - 750 1470 - 1490	BU85 (C7S + C16 + C12)	Z1180
1500 x 800	770 - 790 1470 - 1490	BU86 (C7S + C16 + C13)	Z1181
1700 x 760	730 - 750 1670 - 1690	BU89 (C8S + C16 + C12)	Z1184
1700 x 800	770 - 790 1670 - 1690	BU90 (C8S + C16 + C13)	Z1185

# *ACCESSORIES, RADIATORS & LIGHTS*

Both Burlington and Arcade bathrooms offer a range of accessories, radiators, mirrors and lights for the perfect finishing touch to your traditionally styled bathroom.





## BURLINGTON ACCESSORIES

Continue luxury styling throughout your classic themed bathroom with a range of accessories combining chrome plated solid brass or New Walnut with White or Black ceramic so your bathroom not only looks beautifully traditional but is effortlessly functional too.

· NEW ·



**Accessory back plate**  
W: 30 L: 60 H: 60  
Code: G13 WAL



Walnut accessory backplate - For a high end look or to compliment other walnut options in your bathroom order a G13 WAL and replace your Chrome back plate with a Walnut back plate. See above for examples of accessories with the Walnut backplate. (Compatible with most Burlington accessories - check with your retailer).

· NEW ·



**Soap dish**  
W: 160 L: 150 H: 60  
Code: A1 CHR BLA



**Tumbler holder**  
W: 80 L: 120 H: 110  
Code: A2 CHR BLA



**WC brush holder**  
W: 100 L: 150 H: 430  
Code: A8 CHR BLA

### BLACK ACCESSORIES

Introducing our new Black Accessories. They are the perfect finishing touch and work beautifully with our other black options such as WC seats, brassware and shower valves.



**Soap dish**  
W: 160 L: 150 H: 60  
Code: A1 CHR



**Tumbler holder**  
W: 80 L: 120 H: 110  
Code: A2 CHR



**WC brush holder**  
W: 100 L: 150 H: 430  
Code: A8 CHR



**Accessory back plate**  
W: 30 L: 60 H: 60  
Code: G13



**Single soap dispenser**  
W: 80 L: 140 H: 210  
Code: A19 CHR



**Double soap dispenser**  
W: 190 L: 130 H: 210  
Code: A20 CHR



**Surface mounted soap dispenser**  
W: 70 L: 70 H: 110  
Code: A48 CHR



**Medium ornate bracket**  
W: 230 L: 20 H: 160  
Code: T32 CHR



**WC roll holder**  
W: 80 L: 180 H: 120  
Code: A5 CHR



**WC roll holder**  
W: 100 L: 180 H: 100  
Code: A16 CHR  
Without cover



**Spire WC roll holder**  
W: 170 L: 60 H: 250  
Code: A45 CHR



**Spare WC roll holder**  
W: 120 L: 60 H: 80  
Code: A6 CHR



**Towel ring**  
W: 170 L: 60 H: 200  
Code: A3 CHR



**Robe hook**  
W: 60 L: 60 H: 60  
Code: A14 CHR



**Double robe hook**  
W: 60 L: 110 H: 120  
Code: A4 CHR



**Triple robe hook**  
W: 100 L: 70 H: 90  
Code: A47 CHR

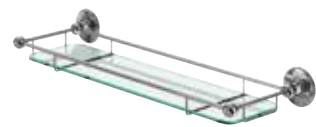

**Glass shelf with railing**  
W: 530 L: 160 H: 60  
Code: A18 CHR



**Brass extendible bath rack**  
W: 590-900 L: 210 H: 90  
Code: A27 CHR



**Towel rack**  
W: 660 L: 320 H: 140  
Code: A46 CHR



**Soap basket**  
W: 140 L: 120 H: 60  
Code: A13 CHR



**Sponge basket**  
W: 220 L: 180 H: 60  
Code: A15 CHR



**Wire basket**  
W: 330 L: 160 H: 90  
Code: A23 CHR



**Corner basket**  
W: 220 L: 220 H: 60  
Code: A21 CHR



**Corner basket**  
W: 280 L: 280 H: 60  
Code: A22 CHR



**Burlington bath basket**  
W: 290 L: 240 H: 110  
Code: A50 CHR



**Angled rail with soap basket left hand**  
W: 435 L: 124 H: 201  
Code: A52 CHR



**Angled rail with soap basket right hand**  
W: 435 L: 124 H: 201  
Code: A53 CHR



**Straight rail**  
W: 460 L: 90 H: 60  
Code: A54 CHR



**Angled rail**  
W: 396 L: 89 H: 190  
Code: A55 CHR



**Single towel rail**  
W: 550 L: 60 H: 60  
Code: A7 CHR



**Double towel rail**  
W: 660 L: 150 H: 170  
Code: A17 CHR



# BURLINGTON RADIATORS



**Trafalgar**

W: 642 L: 235 H: 950  
Code: R1 CHR

**Trafalgar Black**

W: 642 L: 235 H: 950  
Code: R1 CHR BLA

**Bloomsbury**

W: 497 L: 235 H: 950  
Code: R2 CHR

**Bloomsbury Black**

W: 497 L: 235 H: 950  
Code: R2 CHR BLA



**Vincent**

W: 642 L: 235 H: 950  
Code: R5 CHR

**Berkeley**

W: 642 L: 235 H: 950  
Code: R4 CHR

**Cleaver**

W: 642 L: 235 H: 950  
Code: R3 CHR

**Strand**

W: 642 L: 390 H: 404  
Code: R11 CHR



**Chaplin**

W: 542 L: 126 H: 1142  
Code: R12 CHR



**400W summer electric heating kit for Trafalgar**

Code: R10 CHR

**250W summer electric heating kit for Bloomsbury & Vincent**

Code: R9 CHR

**400W summer electric heating kit for Chaplin, Cleaver & Berkeley**

Code: R8 CHR



**Straight Radiator valves**

W: 85 L: 99 H: 235  
Code: R7 CHR



**Angled Radiator valves**

W: 85 L: 65 H: 235  
Code: R6 CHR



**Angled Black Radiator valves**

W: 85 L: 65 H: 235  
Code: R6 CHR BLA

Burlington radiators offer a broad range of various styles, with the recent addition of two black radiators.

There are options here to complement your traditional bathroom beautifully. All Burlington radiators except the Strand (R11 CHR) are designed to work with the extra fitting of an electric summer heating kit, allowing warm towels all year round.

Type	ΔT=50°C Watts	ΔT=55°C Watts	ΔT=60°C Watts	BTU's
Trafalgar	558	623	688	2346
Bloomsbury	387	430	473	1613
Vincent	206	227	246	839
Berkeley	238	263	289	985
Cleaver	266	294	323	1101
Strand	153	174	196	669
Chaplin	320	372	408	1392

## BURLINGTON MIRRORS



**Distressed aluminium frame**  
W: 550 D: 40 H: 750  
Code: T37 ALU



**Black aluminium frame**  
W: 550 D: 40 H: 750  
Code: T47 BLA



**White aluminium frame**  
W: 550 D: 40 H: 750  
Code: T42 WHI



**Arched**  
W: 500 D: 30 H: 700  
Code: A9



**Rectangular**  
W: 500 D: 30 H: 700  
Code: A11



**Curved**  
W: 500 D: 30 H: 700  
Code: A38



**Cosmetic wall mirror chrome**  
W: 180 D: 285 H: 340-440  
Code: A57 CHR

## BURLINGTON LIGHTS



**Burlington round light with chrome base and cup frosted glass shade**  
Code: BL11



**Burlington round light with chrome base and vase clear glass shade**  
Code: BL14



**Burlington round light with chrome base and tube frosted glass shade**  
Code: BL13



**Burlington round light with chrome base and fine pleated shade in white**  
Code: BL12



**Burlington round light with chrome base and chiffon silver shade**  
Code: BL15



**Burlington ornate light with chrome base and cup frosted glass shade**  
Code: BL21



**Burlington ornate light with chrome base and vase clear glass shade**  
Code: BL24



**Burlington ornate light with chrome base and tube frosted glass shade**  
Code: BL23



**Burlington ornate light with chrome base and fine pleated shade in white**  
Code: BL22



**Burlington ornate light with chrome base and chiffon silver shade**  
Code: BL25



**Edwardian single round LED light - chrome**  
Code: T50



**Edwardian single elliptical LED light - chrome**  
Code: T52



# ARCADE ACCESSORIES



Nickel Chrome

Our entire collection of accessories, radiators, mirrors and lights are available in both chrome and nickel finishes, so that you can match your chosen aesthetic across your entire Arcade bathroom.



**Wall-mounted china soap dish**  
W: 160 L: 161 H: 60  
Nickel: ARCA1 NKL  
Chrome: ARCA1 CHR



**Tumbler holder**  
W: 80 L: 126 H: 110  
Nickel: ARCA2 NKL  
Chrome: ARCA2 CHR



**Wall-mounted single soap dispenser ceramic**  
W: 80 L: 141 H: 212  
Nickel: ARCA19 NKL  
Chrome: ARCA19 CHR



**Wall-mounted brush and china holder**  
W: 118 L: 164 H: 402  
Nickel: ARCA8 NKL  
Chrome: ARCA8 CHR



**Bottle trap with extended wall tube**  
Nickel: ARCW14 NKL  
Chrome: ARCW14 CHR



**Bidet trap**  
Nickel: ARCW27 NKL  
Chrome: ARCW27 CHR



**Exposed P trap**  
Nickel: ARCCW3 NKL  
Chrome: ARCCW3 CHR



**Bath overflow, plug and chain**  
Nickel: ARCW3 NKL  
Chrome: ARCW3 CHR



**Wall-mounted towel ring**  
W: 170 L: 59 H: 194  
Nickel: ARCA3 NKL  
Chrome: ARCA3 CHR



**Wall-mounted double robe hook**  
W: 60 L: 105 H: 116  
Nickel: ARCA4 NKL  
Chrome: ARCA4 CHR



**Wall-mounted paper roll holder with brass bar**  
W: 216 L: 93 H: 83  
Nickel: ARCA5 NKL  
Chrome: ARCA5 CHR



**Wall-mounted robe hook**  
W: 60 L: 59 H: 60  
Nickel: ARCA14 NKL  
Chrome: ARCA14 CHR



**Exposed bath trap to floor connection pipe**  
Nickel: ARCW21 NKL  
Chrome: ARCW21 CHR



**Flip top basin waste**  
Nickel: ARCW18 NKL  
Chrome: ARCW18 CHR



**Free-standing paper roll china brush holder**  
W: 257 L: 295 H: 844  
Nickel: ARCA41 NKL  
Chrome: ARCA41 CHR



**Free-standing double paper roll holder**  
W: 376 L: 250 H: 820  
Nickel: ARCA42 NKL  
Chrome: ARCA42 CHR



**Wall-mounted sponge basket**  
W: 269 L: 186 H: 65  
Nickel: ARCA15 NKL  
Chrome: ARCA15 CHR



**Wall-mounted basket**  
W: 330 L: 155 H: 102  
Nickel: ARCA23 NKL  
Chrome: ARCA23 CHR



**Wall-mounted corner basket**  
W: 218 L: 218 H: 102  
Nickel: ARCA22 NKL  
Chrome: ARCA22 CHR



**Wall-mounted extendable rack**  
W: 895 L: 203 H: 70  
Nickel: ARCA27 NKL  
Chrome: ARCA27 CHR



**Free-standing triple tail rail stand**  
W: 376 L: 250 H: 820  
Nickel: ARCA43 NKL  
Chrome: ARCA43 CHR



**Floor-mounted exposed water pipes with support bar**  
Nickel: ARCW7 NKL  
Chrome: ARCW7 CHR



**Floor-mounted exposed decorative shrouds**  
Nickel: ARCW6 NKL  
Chrome: ARCW6 CHR



**Exposed bath overflow, waste, plug and chain**  
Nickel: ARCW4 NKL  
Chrome: ARCW4 CHR

## ARCADE RADIATORS & MIRRORS



### Landsdowne / Trafalgar

W: 600 L: 235 H: 950  
Landsdowne: ARCR1 NKL  
Trafalgar: ARCR1 CHR



### Bruton / Bloomsbury

W: 457 L: 235 H: 950  
Bruton: ARCR2 NKL  
Bloomsbury: ARCR2 CHR



### Babble / Cleaver

W: 600 L: 235 H: 667  
Babble: ARCR3 NKL  
Cleaver: ARCR3 CHR



### Angled radiator valve

W: 65 L: 65 H: 125  
Nickel: ARCR6 NKL  
Chrome: ARCR6 CHR



### Straight radiator valve

W: 65 L: 86 H: 99  
Nickel: ARCR7 NKL  
Chrome: ARCR7 CHR



### Rectangular swivel mirror with curved corners and nickel/chrome plated brass wall mounts

W: 590 D: 66 H: 620  
Nickel: ARCA40 NKL  
Chrome: ARCA40 CHR



### Square swivel mirror with nickel/chrome plated brass wall mounts

W: 590 D: 66 H: 500  
Nickel: ARCA39 NKL  
Chrome: ARCA39 CHR

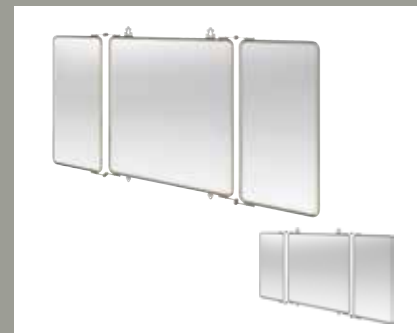

### Three fold bathroom mirror with nickel/chrome plated brass frame

W: 1143 D: 30 H: 600  
Nickel: ARCA45 NKL  
Chrome: ARCA45 CHR

## ARCADE LIGHTS



### Round light with chrome base and cup frosted glass shade

Code: ARCBL11



### Round light with chrome base and vase clear glass shade

Code: ARCBL14



### Burlington round light with chrome base and tube frosted glass shade

Code: ARCBL13



### Round light with chrome base and fine pleated shade in white

Code: ARCBL12



### Round light with chrome base and chiffon silver shade

Code: ARCBL15



### Oval nickel base with cup frosted glass shade

Code: AL11



### Oval nickel base with vase clear glass shade

Code: AL14



### Oval nickel base with tube frosted glass shade

Code: AL13



### Oval nickel base with fine pleated shade in white

Code: AL12



### Oval nickel base with chiffon silver shade

Code: AL15





*Burlington*<sup>®</sup>



Burlington  
+44 (0)1322 473 222  
info@bathroombrands.com  
burlingtonbathrooms.com

Lake View House  
Rennie Drive,  
Dartford  
Kent, DA1 5FU